



VENT

USE AND MAINTENANCE MANUAL

MY 22

VENT 125 Baja + Baja RR / **VENT** 125 Derapage + Derapage RR

This manual is available on the website ventmoto.it to be downloaded and consulted.

VENT is entitled to modify its own models, except for the essential characteristics described and illustrated herein.

All rights of electronic memory, reproduction and total or partial adaptation, whatever the means, are reserved in all countries.

Mentions of products or services provided by third parties are for information purposes only and do not represent any commitment whatsoever.

VENT cannot be held liable for the services or the use of these products.

Edition: 04/2022.

Produced by:
DUESSE SERVICE srl
Samarate (VA)
www.duesse.it

On behalf of:
VENT srl
I - 23815 Introbio (Lecco) - Via alla Cascata 5/7
Phone: +39 (0341) 901-533 (R.A.)
Fax: +39 (0341) 901-457
E-mail: info@ventmoto.it

MAIN INDEX

SAFETY MESSAGES	4	DASHBOARD	18	FUEL TANK CAP	39
WARNINGS - PRECAUTIONS -		ODOMETER	18	AIR FILTER	40
GENERAL WARNINGS.....	4	INSTRUCTIONS TO USE THE VEHICLE	21	TRANSMISSION CHAIN	43
CATALYTIC DISCHARGE SYSTEM	4	GENERAL CHECKS PRIOR TO USE	21	FRONT SUSPENSION	45
SAFETY RULES.....	4	CLIMBING ON AND OFF THE VEHICLE.....	21	REAR SUSPENSION.....	45
PERMITTED USE	5	BREAK-IN.....	22	SPARK PLUG.....	47
CLOTHING.....	5	ADJUSTING REAR-VIEW MIRRORS	22	FRONT BRAKE COMMAND LEVER.....	48
ACCESSORIES	5	PLACING THE VEHICLE ON THE SIDE		COMBINED BRAKING COMMAND LEVER....	48
LUGGAGE	5	KICKSTAND	23	CLUTCH COMMAND LEVER	49
FUEL.....	6	FUELLING	23	ACCELERATOR COMMAND REGULATION...	50
ENGINE OIL	6	STARTING THE ENGINE.....	24	BATTERY	51
BRAKE FLUID	6	ON YOUR WAY	25	TYPE OF RECHARGE	52
COOLING FLUID	7	STOPPING THE VEHICLE	26	FUSES.....	52
EXHAUST FUMES	7	STOPPING THE ENGINE	26	LIGHT BEAM	53
BATTERY	7	PRELIMINARY OPERATIONS	26	FRONT HEADLIGHT	54
SAFE DRIVING	7	THINGS YOU SHOULD KNOW.....	27	REAR HEADLIGHT BULB	55
PARKING	8	SCHEDULED MAINTENANCE SHEETS	28	FRONT AND REAR BLINKERS	55
IDENTIFICATION	9	PARTS REMOVAL	30	TRANSPORTATION.....	56
VEHICLE IDENTIFICATION.....	9	REMOVING THE SEAT.....	30	CLEANING.....	56
ENGINE IDENTIFICATION	9	REMOVING THE LEFT FRONT CONVEYOR...	30	WASHING	56
MAIN ELEMENTS.....	10	REMOVING THE WHEELS	31	STORAGE	57
MAIN ELEMENTS ON THE LEFT SIDE	10	DISASSEMBLING THE FRONT		TECHNICAL SPECIFICATIONS.....	59
MAIN ELEMENTS ON THE RIGHT SIDE.....	12	LIGHT HOLDER	33		
COMMANDS.....	14	CHECKS	34		
START SWITCH	14	ENGINE OIL LEVEL CHECK	34		
START BUTTON.....	14	BRAKE FLUID LEVEL CHECK	35		
LEFT SWITCH	15	BRAKE LINING CHECK.....	36		
CLUTCH COMMAND	15	COOLING FLUID LEVEL CHECK.....	36		
ACCELERATOR COMMAND.....	15	CHECKING THE TYRES.....	37		
FRONT BRAKE COMMAND	16	INSPECTIONS AND REGULATIONS.....	38		
COMBINED BRAKING COMMAND	16	SIDE KICKSTAND.....	38		
CLUTCH COMMAND LEVER	17	HANDLEBAR.....	38		
STEERING LOCK	17	SWINGARM	39		

SAFETY MESSAGES

This symbol indicates a safety message.

When this symbol  appears in the manual, pay particular attention to the potential risk of harm. Failing to heed the warnings that contain this symbol may compromise your own safety as well as that of other people and of the vehicle!

The following words are used throughout the manual to indicate:

DANGER

Potential risk of serious injury or death for the operator or other people.

WARNING

Potential risk of light injuries for the operator or other people, or damage to the vehicle.

NOTE: *The term “NOTE” precedes important information or instructions.*

WARNINGS - PRECAUTIONS - GENERAL WARNINGS

Before using or operating the vehicle, read this manual very carefully, paying particular attention to the chapter “SAFETY RULES”.

Your safety and that of others depend on:

- Being familiar with the vehicle in your possession;
- The efficiency and maintenance status of your vehicle;
- Being familiar with and respecting the Highway Code;
- Your familiarity with movements on the vehicle.

To familiarise yourself with the vehicle, choose an area away from traffic and devoid of dangers to practice.

VENT thanks you for choosing one of our products and wishes you a pleasant drive.

Catalytic discharge system

The catalytic discharge system must be able to work at high temperatures, which remain for a certain period of time even after the engine has been turned off.

DANGER

Do not touch or move objects, especially flammable ones, near the catalytic discharge system until it is completely cold.

Park the vehicle away from dry brush or places accessible to children.

WARNING

To avoid damage to the catalytic discharge system, use only lead-free gasoline.

SAFETY RULES

- To drive this vehicle it is necessary to possess all requisites defined by the law in force in the Country where it is used.
- Taking certain medications, alcohol or other drugs increases the risk of accidents. Make sure you are psychologically and physically able to drive, focusing particularly on physical fatigue and drowsiness.
- Another significant cause of accidents is driver's inexperience. **DO NOT** entrust the vehicle to beginners, and make sure the driver possesses the necessary requisites to drive.
- Always respect road signs and highway laws, nationally and locally.
- Avoid sudden manoeuvres, which are dangerous for yourself and for others (for

example, wheeling, failing to respect the speed limit etc).

Assess driving conditions:

- Visibility;
- Road conditions;
- Traffic;
- Presence or possible presence of pedestrians.

Rule out and avoid obstacles that may cause damage to the vehicle or lead to loss of control of the vehicle.

- Respect and maintain all safety distances.
- Always drive holding the steering wheel with both hands, with your feet resting on the driver's footrests, i.e. In the proper driving position.
- Pay maximum attention to the act of driving and to the traffic on the road.
- If the vehicle has been in an accident or has been in a crash or fall, make sure the command levers, the tubes, the cables, the braking system, the wheels, the tyres and all other parts are intact.

If the damage is persistent or if you are uncertain of its conditions, take the car to a **VENT** dealer, where the vehicle will be tested and inspected.

Always report any case of malfunctioning to make it easier for the technicians and/or mechanics to solve the problem.

⚠ DANGER ⚠

Do not drive or allow anyone to drive the vehicle if the damage it has suffered is compromising its safety.

- It is forbidden to carry out any modification to the vehicle.

NOTE: *Making modifications to the vehicle will result in warranty annulment.*

- It is advisable to follow all national and local laws and regulations regarding vehicle equipment.
- It is forbidden to use the vehicle to race, except for competitions in tracks set apart for this purpose.

Permitted use

Baja models are intended for use on the road and off-road.

Derapage models are intended exclusively for use on the road.

Clothing

- Always wear and properly snap shut the helmet, which must be approved according to the laws in force in the country where it is being used.
- It is advisable to wear protective garments in the event of falls, such as jacket, trousers, gloves, boots etc, suitable for motorcycle use.

Do not wear exceedingly loose or abundant garments or accessories, as they

may impair driving manoeuvres.

- Do not keep in your pockets any sharp objects that could potentially cause harm in a fall, such as:
 - Keys;
 - Pens;
 - Glass containers etc.
- This also applies to the passenger.

Accessories:

It is advisable to purchase and install original accessories from a **VENT** dealer. Users are personally responsible for choosing and installing accessories.

Luggage

- Be prudent when loading luggage. Do not overload.
- Maintain the luggage as close as possible to the barycentre of the vehicle.
- Distribute the load uniformly on both sides to reduce imbalances.
- The load must be firmly anchored to the vehicle.
- Never rest any loads on the handlebars, swingarm or front mudguard.
- Exceedingly voluminous loads, or anything that protrudes too much from the limits of the vehicle, may cause crashes and therefore injury and damage to animals or things and compromise the stability of the vehicle, with dangerous

consequences.

- It is forbidden to transport any load that protrudes exceedingly or that covers the acoustic and visual signalling devices.
- Overloading the vehicle compromises its stability and manoeuvrability.

Fuel

⚠ DANGER ⚠

Fuel is highly flammable, harmful for the health and dangerous for the environment.

⚠ DANGER ⚠

Do never use your mouth to pump fuel from the tank using tubes or any other means.

- When filling up the tank, never use free flames, do not smoke, and keep the engine off.
Avoid inhaling fuel fumes and keep the fuel from coming into contact with eyes or skin.
If any fuel comes into contact with your clothes, change them immediately.

⚠ WARNING ⚠

If you feel ill due to inhaling fuel fumes, stay outdoors and seek medical help. If fuel comes into contact with your eyes, rinse abundantly with water. If it comes

into contact with your skin, wash abundantly with water and soap. In the event of fuel ingestion, seek medical help immediately.

⚠ DANGER ⚠

Be careful not to pour fuel over the engine or the exhaust pipe; fire hazard. If this happens, wash and rinse the area involved.

⚠ DANGER ⚠

KEEP AWAY FROM THE REACH OF CHILDREN. DO NOT DISPOSE OF ENGINE OIL IN THE ENVIRONMENT.

- Never fill up the tank to the top; stop at the maximum level permitted, indicated in the relative paragraph "Refueling".

Engine oil

⚠ DANGER ⚠

Engine oil is highly flammable, harmful for the health and dangerous for the environment.

- During maintenance operations, always wear latex gloves to protect your hands.

⚠ WARNING ⚠

If the oil comes into contact with your eyes, rinse abundantly with water. If it comes into contact with your skin, wash abundantly with water and soap. In the event of engine oil ingestion, seek medical help immediately.

⚠ DANGER ⚠

KEEP AWAY FROM THE REACH OF CHILDREN. DO NOT DISPOSE OF ENGINE OIL IN THE ENVIRONMENT.

- Used oil must be collected in a suitable container and taken to a recycling centre.

Brake fluid

⚠ DANGER ⚠

Brake fluid is highly flammable, harmful for the health and dangerous for the environment.

- During maintenance operations, always wear latex gloves to protect your hands.

⚠ WARNING ⚠

If brake fluid comes into contact with your eyes, rinse abundantly with water. If it comes into contact with your skin, wash abundantly with water and soap.

In the event of brake fluid ingestion, seek medical help immediately.

Cooling fluid

⚠ DANGER ⚠

Cooling fluid is highly flammable, harmful for the health and dangerous for the environment.

- When filling up or replacing cooling fluid, never use free flames, do not smoke, and keep the engine off.

Avoid inhaling cooling fluid and keep the fuel from coming into contact with eyes or skin.

If any cooling fluid comes into contact with your clothes, change them immediately.

⚠ WARNING ⚠

If brake fluid comes into contact with your eyes, rinse abundantly with water. If it comes into contact with your skin, wash abundantly with water and soap.

In the event of brake fluid ingestion, seek medical help immediately.

⚠ DANGER ⚠

Be careful not to pour cooling fluid over the engine or the exhaust pipe; risk of fire with invisible flames. If this happens, wash and rinse the area involved.

⚠ DANGER ⚠

KEEP AWAY FROM THE REACH OF CHILDREN.

DO NOT DISPOSE OF ENGINE OIL IN THE ENVIRONMENT.

- Never fill up the radiator to the top; stop at the maximum level permitted, indicated in the relative paragraph “**Cooling fluid level check**”.

Exhaust fumes

⚠ DANGER ⚠

Exhaust fumes consist of carbon monoxide, an extremely harmful substance if inhaled.

Avoid starting the engine in closed spaces or anywhere with poor ventilation.

Failure to follow this recommendation may result in loss of senses and even death by asphyxia.

Battery

⚠ DANGER ⚠

The battery releases explosive gases; keep away from sparks and free flames. Do not smoke. When recharging the battery, make sure there is sufficient air circulation in the area.

SAFE DRIVING

This paragraph offers some suggestions for driving/riding safely.

ACCELERATION. Accelerating and decelerating repeatedly without true need may cause loss of vehicle control and result in fall, with serious consequences for yourself, for others, and for the vehicle.

BRAKING. To reduce speed in a uniform, optimal manner:

- Decelerate and always use both brakes, suitably dosing the amount of force applied on the brake levers;
- Avoid close braking whenever possible.

Using only one of the brakes:

- Reduces braking force;
- Risks locking the braking wheel;
- Contributes to loss of adherence and to the possibility of falling, with serious consequences for themselves and for others, as well as for the vehicle.

BRAKING IN ASCENT. Decelerate completely and use both brakes to keep the vehicle in place.

Using motion force (using the accelerator) to keep the vehicle in place causes anomalous overheating of the engine and of the clutch.

Keeping the vehicle in place using only physical strength may cause loss of balance and fall, with serious consequences for yourself, for others and for the vehicle.

FACING AND RIDING A

CURVE. Do not ride into a curve at high speed.

Do not underestimate the difficulty involved in negotiating a curve; slow down before facing it.

When you see a curve up ahead, reduce your speed by decelerating and then braking. Negotiate the curve at constant speed or at moderate acceleration, being careful not to lose adherence with the terrain or control of the vehicle. If it is necessary to use the brakes, do it with moderation and attention.

NEGOTIATING DESCENTS: Never ride the vehicle with the engine off in descents. Using only the brakes when riding down a slope causes overheat in the friction material (brake linings or shoes) and consequently reduces brake effectiveness.

Combine the use of brakes and the compression of engine power (scaling the shifts correctly).

DRIVING WHEN VISIBILITY IS POOR. It is obviously not advisable to drive/ride when visibility is poor (due to rain, fog, mist etc); if possible, it is always better to stop and wait until visibility conditions improve before resuming your trip.

DRIVING/RIDING WHEN ROAD ADHERENCE IS POOR.

Whenever possible, avoid driving/riding in such conditions (snow, ice, mud etc). If

necessary, proceed at moderate speed and avoid sudden manoeuvres; always brake with caution so as to avoid losing control of the vehicle.

OBSTACLES AND TRAPS ON THE ROAD.

Disconnected roads, manholes, sudden depressions, bumps, rail tracks, road signs painted over, metal slabs belonging to building sites along the road, may all be slippery or otherwise jeopardise, even if only temporarily, vehicle stability, causing falls with serious consequences for yourself, for others and for the vehicle.

CHANGING LANES OR DIRECTION. Always activate the blinkers when changing lanes or direction, and carry out the manoeuvres with regularity. Turn off the blinkers after use.

OVERTAKE CAREFULLY Whenever overtaking another vehicle or when you are being overtaken yourself, be particularly attentive. Water splashes when the road is wet and the slipstream caused by the motion of large vehicles can cause loss of control of the vehicle and the possibility of falling, with serious consequences for yourself, for others and for the vehicle.

▲ WARNING ▲

Always follow the recommended indications when driving/riding.

PARKING

▲ DANGER ▲

Accidentally falling from the vehicle can cause:

- Fuel leaking from the tank, resulting in fire hazard;
- Cooling fluid leaks;
- Engine oil leaks;
- Damages to people, things and the vehicle itself.

To avoid accidental falls with the vehicle, choose a solid, flat terrain and an area of suitable size for the vehicle and for parking manoeuvres.

▲ DANGER ▲

Make sure the terrain is not exceedingly inclined.

Always check the motorbike for stability after lowering it on its kickstand.

If you must park on inclined terrain, park your motorbike facing uphill, so that its weight will keep the kickstand in place and prevent it from caving in.

- Do not leave the vehicle sideways on the ground or leaning on walls, fences, handrails etc.
- The vehicle must always be parked on its kickstand.

⚠ DANGER ⚠

The parked vehicle, and in particular its overheated parts, must not be a hazard for children, people or animals. **NEVER** leave the vehicle parked with the engine running.

NOTE: The kickstand is designed to sustain the combined weight of vehicle and luggage.

- Always use the steering lock.

⚠ WARNING ⚠

Avoid parking or lounging beneath plants or trees.

During some seasons, certain plants and trees drop or release residues, resin, fruits or leaves containing substances that can damage the vehicle (especially its body).

IDENTIFICATION

Vehicle identification

Each VENT vehicle comes with a vehicle identification number (V.I.N.)

This vehicle displays its V.I.N.:

- On the chassis, on the steering head on the right side (A);
- On the SUMMARY PLATE (B), located on the right side of the chassis, near the steering head.

Every request made to the dealer must be accompanied by the V.I.N. of the vehicle in question, so that the dealer can recognise the vehicle and meet your demands.

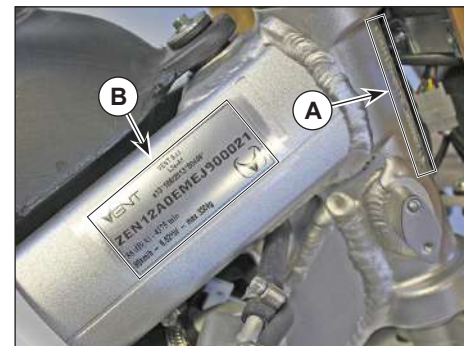

Engine identification

The engine number (C) is printed on the base of the engine casing, on the left lower side.

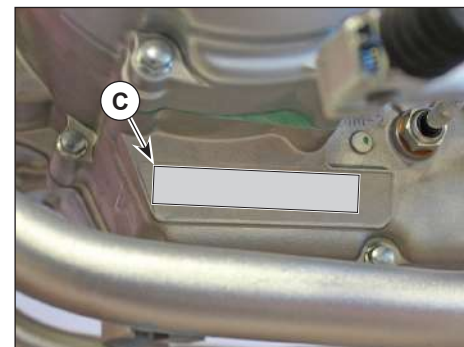

MAIN ELEMENTS

Main elements on the left side

1. Left rear view mirror
2. Buzzer button “🔔”
3. Light switch “☰ - ☲”
4. Blinker switch “↔ ↔”
5. Buzzer
6. Air filter
7. Saddle
8. Fuse holder
9. Clutch lever
10. Voltage regulator
11. Clutch command lever
12. Pilot's left foothold (with spring, always open)
13. Side kickstand
14. Transmission chain
15. Battery
16. Contactor
17. Contactor fuse
18. Direction indicators intermittence
19. Front brake pincers
20. Front brake disk
21. Front headlight
22. Front blinkers
23. Relays
24. Canister
25. Left silencer

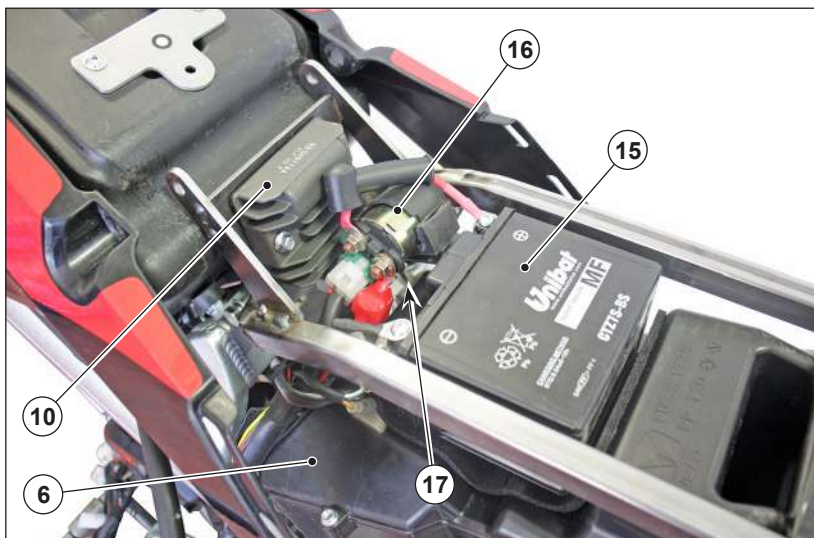
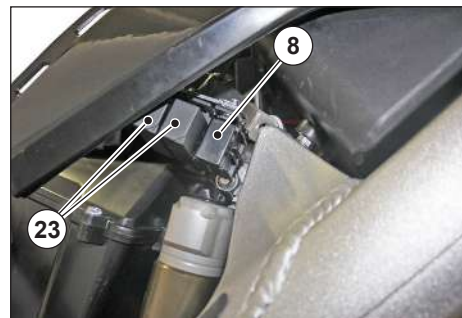
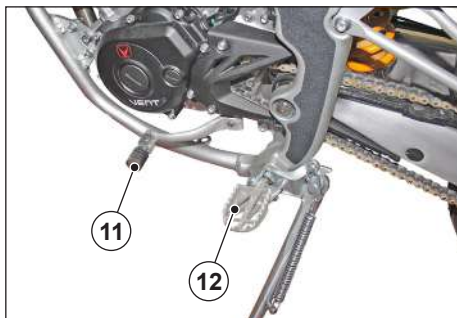



Main elements on the right side

1. Start and stop switch
2. Right rear view mirror
3. Fuel tank cap
4. Fuel tank
5. Cooling fluid radiator cap
6. Cooling fluid radiator
7. Engine oil level rod-cap
8. Engine oil drain plug
9. Rear brake command lever
10. Pilot's right foothold (with spring, always open)
11. Front brake fluid reservoir
12. Front brake command lever
13. Accelerator
14. Dashboard
15. Steering lock
16. Spark plug
17. Start button
18. Rear brake fluid reservoir
19. Engine oil filter cap
20. Rear brake lever knob
21. Cooling fan
22. Right silencer
23. Rear brake pincers
24. Rear brake disk
25. Rear light/plate light
26. Rear blinkers

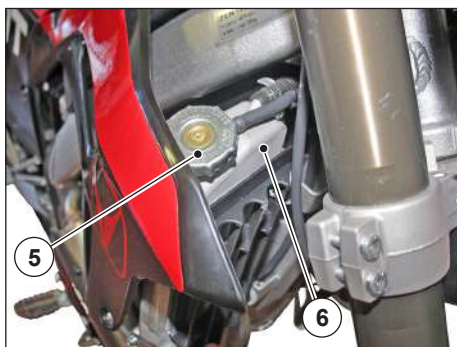
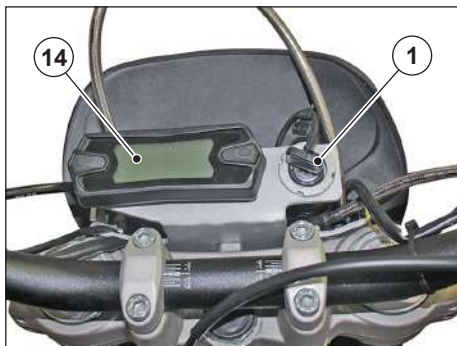

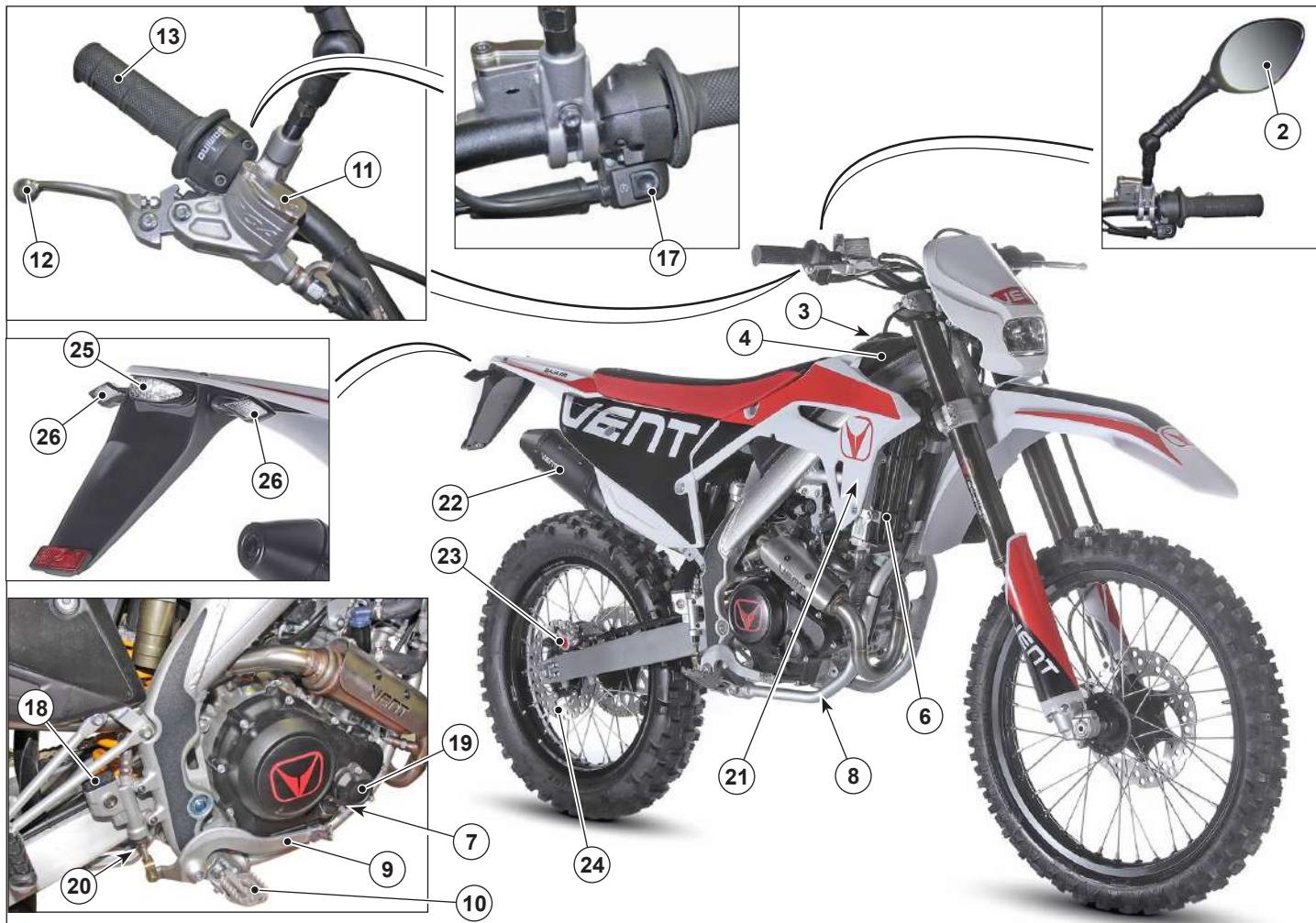

COMMANDS

Start switch

The start switch has two positions:

☒ “OFF” position, key removal;

↻ “ON” position, motorbike start (key cannot be removed);

- Key extraction position ☒

When the key is turned to the “☒” position, the engine and the lights are turned off and voltage is cut off from the circuits. In this position, the key can be removed from the switch.

- Start position ↻

From the “☒” OFF key removal position, turn the key (1) clockwise to the “↻” ON position. The lights will light up and the display will show that the circuits are live. It is now possible to start the motorcycle.

⚠ DANGER ⚠

Do not tamper with the engine on/off key (1) while the engine is running. This would temporarily stop the engine and then restart it when the key is used. This

might damage the engine and especially cause loss of vehicle control, with possible serious consequences for people, things and the vehicle itself.

Start button

Press the start button (1), with the start switch at the ON “↻” position, the engine will start.

⚠ WARNING ⚠

Avoid pressing the start button “Ⓢ” (1) when the engine is on: this might damage the starter.

For the engine start procedure, see the paragraph on “Starting the engine”.

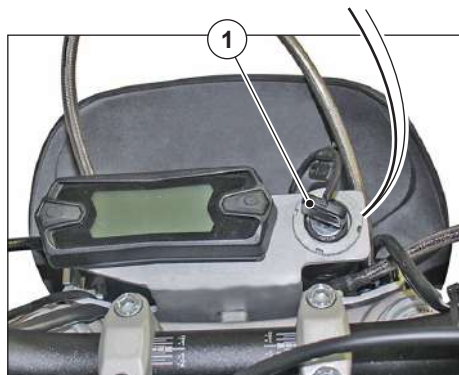
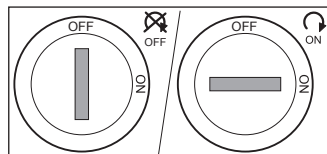

Left switch

Honk “”





Press the button (1) to honk.

WARNING

The use of the honk must be limited by the laws of the road and to specific prohibitions.

Light switch “ - ”

NOTE: When the light switch is in “ON” position, the passing and position lamp is always switched on.

- The light switch “ - ” (2) has two positions:
 - in the “”, position, the dipped beams are turned on.
 - In position “”, the driving and position lamp is switched on and the relative indicator lights up on the dashboard.

Blinkers “ ⇄”

The blinker “ ⇄” (3) has three positions, returning to the centre position:

- when moved to the right and released, it turns on the right blinker. Its relative warning light on the dashboard will turn on;

- When moved to the left and released, it turns on the left blinker. Its relative warning light on the dashboard will turn on.

To turn off the blinker, press the lever (3) once it is back in its central position.

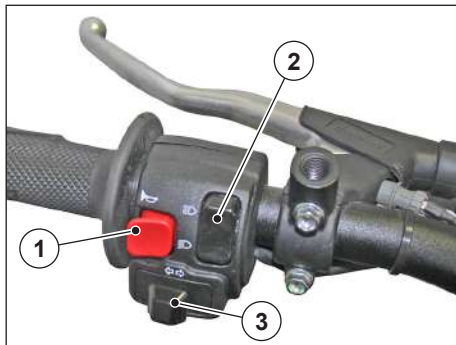

Clutch command

The command lever (1) for the clutch is located to the left of the steering wheel.

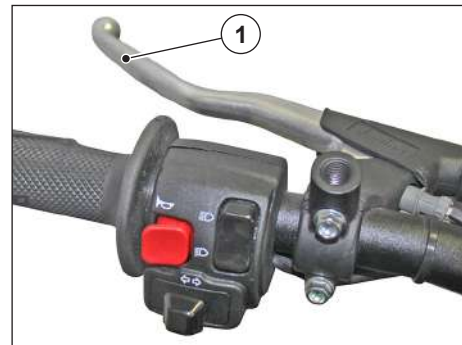

Accelerator command

The accelerator command (1) is located to the right of the steering wheel. According to how much it is turned, the rotations per minute will increase or diminish.

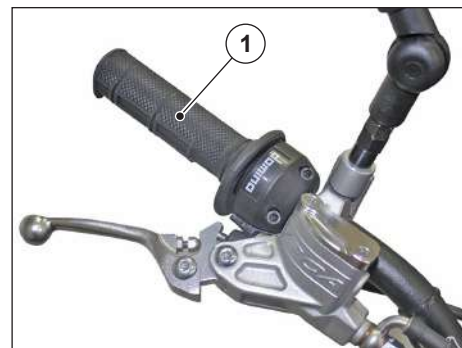

Front brake command

The command lever (1) for the front brake is located to the right of the steering wheel.

NOTE: The lever has a STOP switch: when braking, it lights up the rear stop light.



Combined braking command

The motorcycle is equipped with combined brakes.

- The command pedal (1) for the combined braking is located on the right side of the motorcycle.

NOTE: The pedal has a STOP switch: when braking, it lights up the rear stop light.

- Pull the lever (2) to brake with the front brake;
- Press the pedal (1) for combined braking. The system will split the braking between the front and the rear brakes.

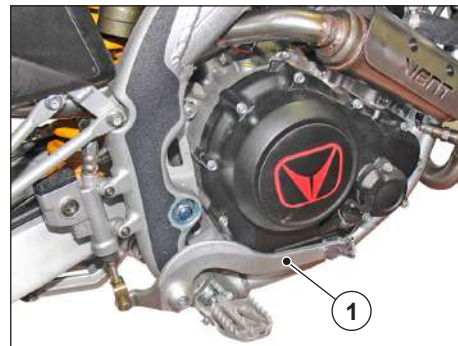

Clutch command lever

This motorcycle is equipped with six gears.

- Use the lever (1) to change gears.

NOTE: After inserting a gear, release the lever (1), which will return to its central position.

⚠ WARNING ⚠

To change the gear, pull the gear lever and lower the number of rpm using the accelerator knob.

- From the N (neutral) position, press the lever (1) downwards to insert the first gear.
- To change to the other gears, move the lever (1) upwards.
- To reduce the gears, proceed in the opposite direction.

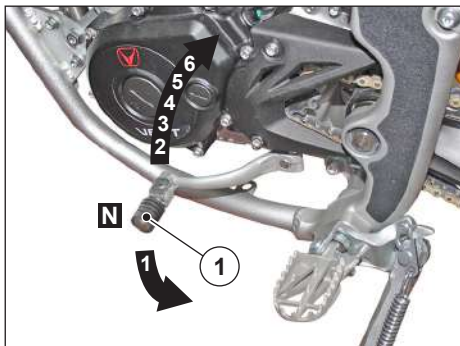

Steering lock

To lock the steering, do the following:

- Park the vehicle on its kickstand.
- Turn the handlebar completely to the left.
- Turn the protection cover (1).
- Insert the key (2) into the lock (3).
- Rotate the key (2) counter-clockwise.
- Press the key (2) inwards and turn it clockwise.
- Remove the key.

To unlock the steering, follow the same instructions in the opposite order.

⚠ WARNING ⚠

Do not leave the key inserted after having unlocking the handlebar; when the handlebar is turned, it may break the key.

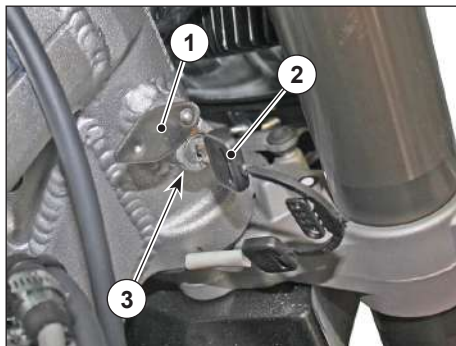

DASHBOARD ODOMETER

The odometer is activated when the start key is in the ON position. ↻

Lights and buttons

1) Backlighting display

2) ↶ ↷ GREEN indicator light on; it lights up flashing when the direction indicator is on.

3) ☰ D BLUE light, high beams are on.

4) N GREEN light, neutral gear.

5) 🛢️ YELLOW light; engine anomaly. It lights up when an engine or exhaust anomaly has happened. Go to the nearest **VENT Dealer**.

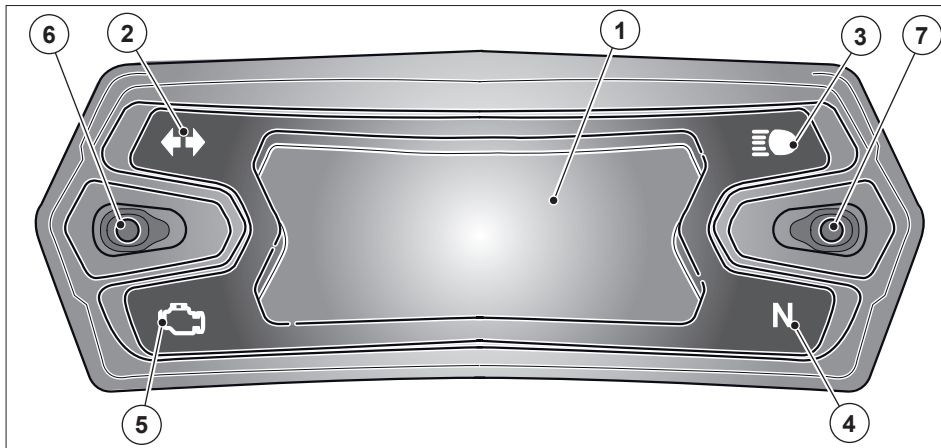

6) **MODE** button
Multi-function button. Pressing during use will display, in sequence:

- Total km/miles
- Trip A
- Trip B
- Total hours running
- Trip A hours running
- Trip B hours running

7) **SET** button
Allows the functions to be selected or partial values to be reset.

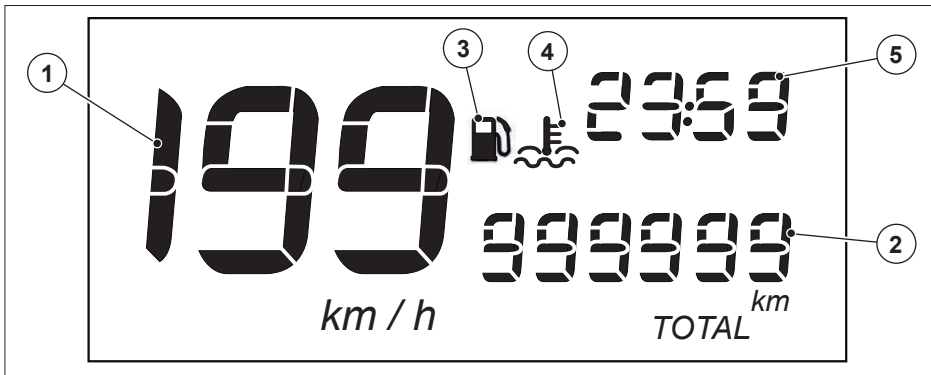

CAUTION

When the fuel of mixing oil reach the minimum level, as well as the relative LEDs (3) and (4) lighting up, the entire display flashes.

1) Speedometer

Indicates the speed of the vehicle

2) Multidata display

This part of the display can show the following information:

Odometer (ODO)

- Total km/miles covered
- Maximum 99,999 km/miles; once this maximum value has been reached, the odometer resets itself and starts counting from 0 again. Minimum: 1 km/mile

“Total” or partial running hours for Trip A and Trip B

It is possible to set two partial counters, Trip A and Trip B, and a Total hour counter.

Indicator of maximum hours covered, maximum 9999.9 hours; once this maximum value has been reached, the odometer resets itself and starts counting from 0 again. Minimum: 0.1 hour.

Indicator of total hours covered, maximum 99999.9 hours; once this maximum value has been reached, the odometer resets itself and starts counting from 0 again. Minimum: 0.1 hour.

Reset partial values

To reset the partial values Trip A, Trip B, proceed as follows:

- Press the “MODE” (1) until the de-

sired screen is displayed, e.g. Trip A, then press “SET” (1) again for 3 seconds to reset the value.

- Proceed in the same manner for all other screens.

3) Reserve fuel level indicator

This indicator lights up when the fuel level is at its minimum. Drive to the nearest fuel station to fill up the tank.

4) Cooling fluid temperature alarm light

When the warning light is flashing, it means the temperature of the cooling fluid has reached its maximum level allowed. Stop the vehicle, leave the engine at idle for a few seconds, then turn it off. Wait until the temperature of the cooling fluid drops then restart the engine. If the light turns on again, do not use the vehicle. Take it to the nearest **VENT Dealer**.

5) Clock

Operate as follows to adjust the clock:

- Press the “MODE” and “SET” buttons at the same time for at least 2 seconds to change the time
- Press the “MODE” button to adjust the hours
- Press the “SET” button to adjust the minutes

- Press the **“MODE”** and **“SET”** buttons at the same time for at least 2 seconds to confirm the time set.

Unit of measure settings km/miles

- Use the **“MODE”** button to scroll the menu until **“ODO”** or Trip A or B is selected
- Press the **“SET”** button for at least 10 seconds to pass from km to miles or vice versa.

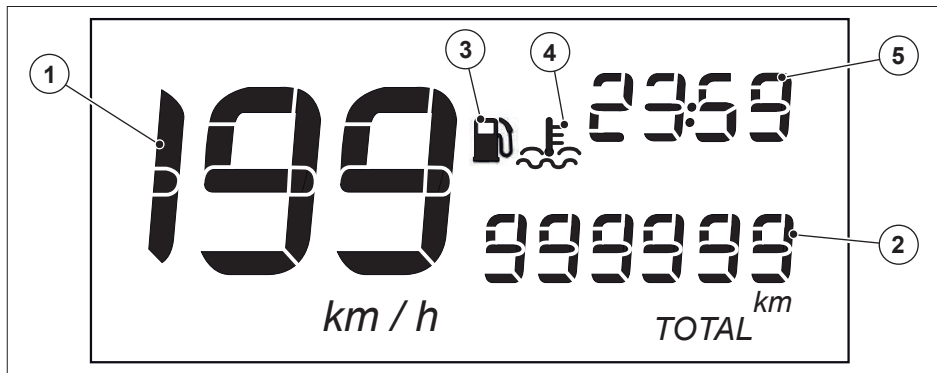

INSTRUCTIONS TO USE THE VEHICLE

General checks prior to use

Every time you are about to ride your motorcycle, go through this checklist:

- Rotate the start key to the ON position and make sure the display lights up;
- Turn on the high beam and make sure its warning light is on;
- Turn on the blinkers and make sure their relative warning lights are on;
- Pull the front brake lever and press the combined brake pedal; make sure the rear stop light turns on;
- Check fuel and engine oil levels;
- Check the brake fluid level in its tank;
- Check the cooling fluid level;
- Make sure the handlebar is working by turning it all the way to the right and to the left;
- Check pressure in the tyres;
- Make sure tension in the chain is adequate.

NOTE: For the inspection operations, please consult their relative paragraphs.

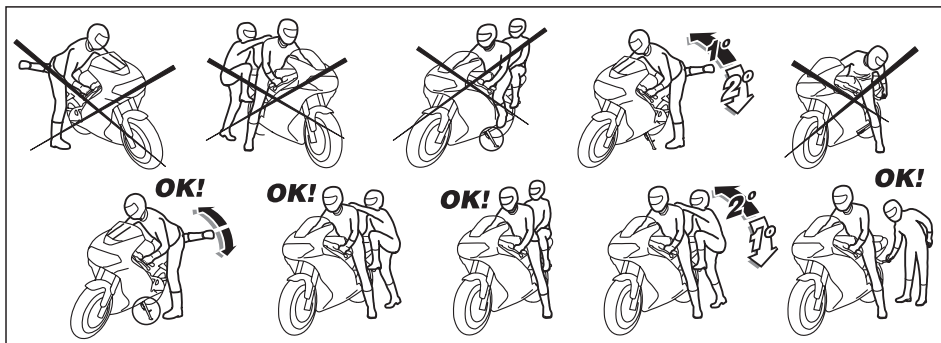

Climbing on and off the vehicle

Pay attention to the instructions below.

They have the goal of keeping the pilot or the passenger from falling from the vehicle and/or the vehicle itself from toppling, which would result in damages to people, things and the vehicle itself.

- Only climb on and off the vehicle if you have freedom of movement; your hands, in particular, must not be holding objects, such as helmet, gloves or glasses.

Climbing on the bike

- With the bike on the side kickstand, the pilot must climb on the motorbike from its left side, with both hands holding the handlebar.
- Once the pilot is on the bike, lift the bike; the side kickstand will automatically lift as well.

⚠ DANGER ⚠

Make sure the side kickstand is fully lifted.

⚠ WARNING ⚠

Do not place the pilot's or the passenger's weight on the side kickstand.

NOTE: If you are unable to rest both your feet on the ground on both sides of the bike, firm your right foot on the ground and keep the left one ready to offer support.

- The passenger must extract the rear footrests and climb from the left side of the bike, using the left footrest while holding on to the pilot.

Climbing off the bike

- First of all, the passenger must climb off the left side of the bike, using the left footrest.
- Once on the ground, the passenger must push the rear footrests back in.
- The pilot must keep his/her hands firm on the handlebar and climb off the left side of the motorcycle, resting his/her left foot on the ground and lifting his/her right leg.
- Once on the ground, lower the kickstand and make sure the motorcycle is resting its weight on it (for kickstand operations, please read the “**Side kickstand**” chapter).

Break-in

Breaking in is crucial for the proper working and duration of the engine.

The break-in means the first kilometres covered.

During break-in, it is necessary to follow certain rules to prepare the parts of the engine and of the vehicle itself for the maximum performance to be demanded later on (after the break-in).

Rules for a good break-in

These rules are only suggestions to help the rider break in the motorcycle properly. Failing to follow them may not result in immediate damage, but can have negative effects on the performance of the engine and of the different parts of the vehicle.

STRESS It is important to “stress” the engine and the other parts of the vehicle in an appropriate manner. It is also important not

to exceed and not to stress insufficiently; in both cases the engine and parts of the vehicle might suffer.

ITINERARIES Do not strain engine, brakes and suspensions in mountain roads.

Give preference to roads with curves and moderate hills, where the engine, the brakes and the suspensions can alternate periods under stress and periods with little or no stress at all.

SPEED Always change the speed gradually, without sudden, complete accelerations. Complete acceleration is allowed, but DO NOT ride for long distances with the accelerator knob fully turned (full regime).

BRAKING New brake linings. In order to be fully operative, the friction surface of brake linings must be broken in, so it adheres perfectly to the disk when braking. A good break-in requires about 200 km (125 miles) of urban distance. During this period, go for longer braking distances and use the brake lever with more intensity. Avoid sudden, long brakes.

NOTE: *The first 500 km (312 miles) are the threshold of end of break-in, but only after the first 1,000 km (625 miles) do the vehicle's best performances occur.*

WARNING

The 500-km break-in threshold (312 miles) requires carrying out the maintenance operations defined for this distance.

Adjusting rear-view mirrors

⚠ DANGER ⚠

Never ride the vehicle with the rear-view mirrors rotated incorrectly.

Before you get going, always make sure the mirrors are in their correct position and adjusted accordingly.

- Climb on to the vehicle, to the pilot position.
- Use the joint (1) to regulate mirror height

(2) and the joint (3) to adjust inclination.

NOTE: *Make sure you, as pilot, can properly see the rear part of the road from your sitting position.*

⚠ DANGER ⚠

Always adjust the mirrors with the motorcycle standing still.

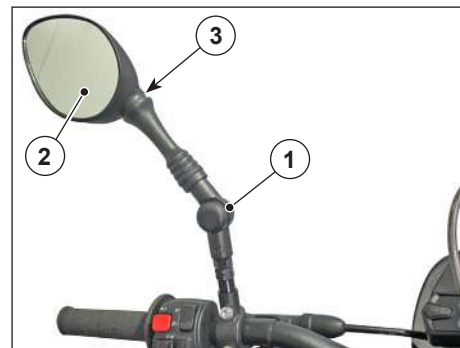

Placing the vehicle on the side

kickstand

This vehicle is only equipped with a side kickstand.

- Hold the left handle and place your right hand on the posterior part of the seat;
- Push the side kickstand (1) with your right foot until it is fully extended;
- Keep the side kickstand in its extended position, then incline the vehicle until the kickstand is on the ground.

▲ WARNING ▲

Make sure the vehicle is stable.

- The rotation of the side kickstand (1) must be free from obstacles.

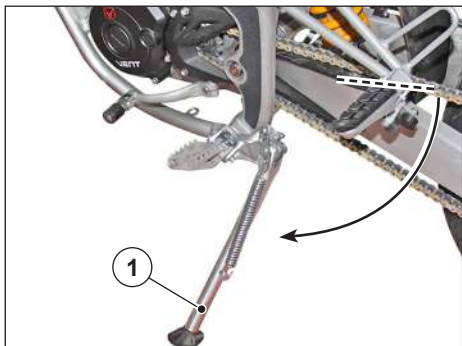

▲ DANGER ▲

The side kickstand automatically goes back to its place when the vehicle is pulled up from its parking position to its working position.

- Once you are sitting on the bike, use your left foot to check the side kickstand and make sure it is completely in its resting position again.
If it is not fully back in, go through the inspections indicated in the Maintenance chapter.

Fuelling

▲ WARNING ▲

For the type of fuel, tank capacity and fuel reserve, please check the “Technical information” paragraph.

- Park the vehicle on its side kickstand;
- Unscrew and remove the cap (1) of the fuel tank.

NOTE: *If you are using a funnel or anything of the kind, make sure it is perfectly clean before use.*

- Do not fill the tank to its maximum capacity; maximum fuel level must remain beneath the lower edge (2) of the shaft.
- After filling up, close the fuel tank cap (1) again.



Starting the engine

- Unlock the handlebar;
- Unlock or remove any additional anti-theft device installed;
- Climb on to the vehicle, to the pilot position.

NOTE: This vehicle is equipped with automatic lights.

- Make sure the light switch (1) is in the low beam position “

NOTE: To start the engine, the gear lever must be in its neutral position “**N**” or in a gear, with the clutch (3) lever pulled.

- Press the start button (5) without accelerating, then release it as soon as the engine starts running.

- If the idling speed is unstable, use the accelerator knob (6) with small and frequent rotations, to warm up the engine and obtain a constant idling speed.

⚠ WARNING ⚠

Avoid pressing the start button (5) when the engine is running: this might damage the starter.

NOTE: To avoid excessive battery consumption, do not keep the start button (5) pressed for more than 5 seconds.

If the engine does not start within this period, wait 10 seconds then press the start button again.

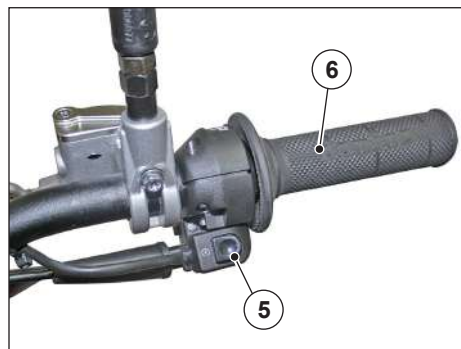
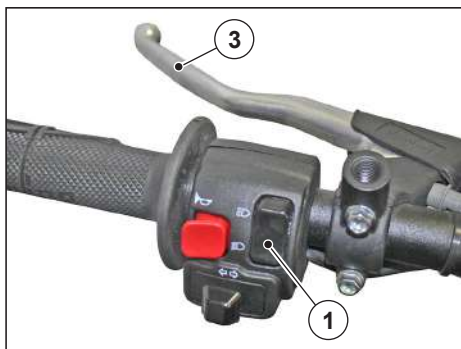
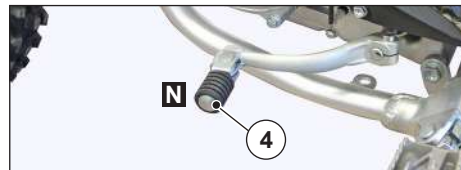

Starting the engine after a long time of inactivity

If the vehicle has remained inactive for a long period of time, starting the engine may not be an easy task, as the fuel feeding circuit may be partially empty.

- It may be necessary to press the start button (1) many times in order to fill the circuit again and allow the engine to start.

Starting the engine when it is flooded

After following the complete starting procedure and observing the engine is flooded:

- Press the start button (1) for a few seconds (so the engine runs empty);
- press the start button (1) without accelerating, then release it as soon as the engine starts running.

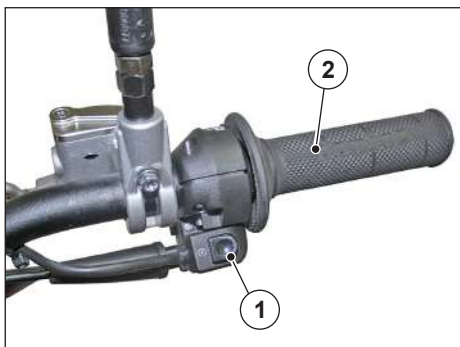



On your way

▲ DANGER ▲

If you are travelling without a passenger, make sure the passenger's footrests are closed. While riding, keep your hands firmly on to the handlebar and your feet on the footrests.

▲ WARNING ▲

Make sure the “” light goes off once the engine is started. If this does not happen, do not use the vehicle: take it to the nearest dealer instead.

NOTE: If the display lights up this symbol , stop to fill up your tank as soon as possible.

- With the accelerator knob (2) released and the engine at its idling speed, fully activate the clutch lever (3).
- Insert the first gear by pushing the gear lever (4) downward.
- Release the brakes activated during engine start.



▲ DANGER ▲

When leaving, releasing the clutch lever too jerkily or quickly may cause the engine to stop and the vehicle to jib.

Do not accelerate jerkily or excessively while releasing the clutch lever; this will keep the clutch from slitting and the front wheel from coming off the ground.

- Slowly release the clutch lever (3), simultaneously accelerating by moderately rotating the accelerator knob (2). The vehicle will begin to move forward.
- Increase speed by gradually rotating the accelerator knob (2), without exceeding the maximum speed limit and the suggested rpm.
- Change gears as indicated in the paragraph on “**Gear lever**”.

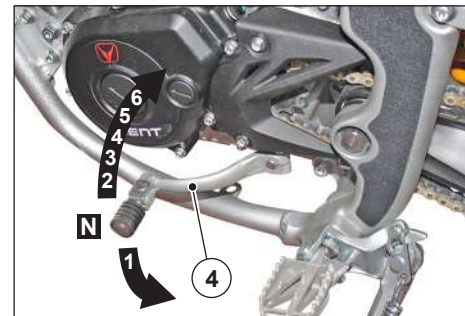

▲ WARNING ▲

Change gears one at a time; stepping up several gears at once may cause the engine to exceed its maximum power and to overrev. Before and during the “scaling up” from one gear to another, always slow down, releasing the accelerator to avoid overrevving.

Stopping the vehicle

- Release the accelerator knob (1), gradually activate the brakes and simultaneously “scale down” the gears to reduce the speed.
- Pull the clutch lever (2) before fully stopping the vehicle, to keep the engine from turning off.
- Place the gear lever (3) in its neutral position.
- Release the clutch lever (2).
- During a temporary stop, keep at least one of the brakes activated.



Stopping the engine

- Stop the vehicle as indicated previously.
 - Rotate the key (4) to the OFF position
- “” and remove it.
- Park the vehicle on its side kickstand as described in its relative paragraph.

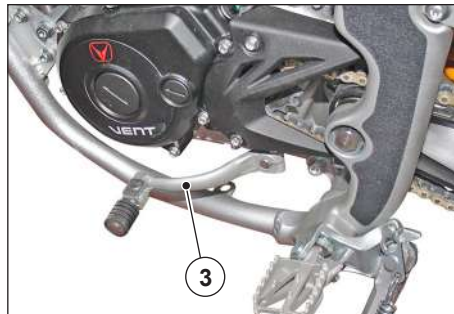

MAINTENANCE

▲ DANGER ▲

Danger of fire or toxic fumes.
Never place flammable substances (such as fuel, cooling fluid, solvents etc) near the electric parts.
Always wear suitable garments (working overalls) and working gloves, latex gloves, protective goggles (or mask) when doing the necessary maintenance operations on the vehicle.

Preliminary operations

- Before starting maintenance operations:
- Turn off the engine;
 - Wait until all overheated parts of the vehicle (engine, silencer etc) are down to room temperature;
 - Make sure the place has suitable ventilation and air circulation;

- Check the maintenance area (it must not be dusty, dirty or occupied with other components not involved in the operations or the vehicle);
- Make sure you have all the tools and pieces of equipment you need for the maintenance operations you must carry out;
- Always wear suitable garments (working overalls) and working gloves, latex gloves, protective goggles (or mask) when doing the necessary maintenance operations on the vehicle;
- Make sure you have all spare parts and fluids you need for the maintenance operations (e.g. brake linings, oil, brake fluid, cooling fluid).

Before intervening on the vehicle:

- Check this manual for torque values and find a torque wrench to work with.

⚠ DANGER ⚠

If you cannot find one, contact a VENT Dealer.

⚠ DANGER ⚠

**Never use your mouth to hold mechanical parts or to carry out interventions of any kind.
The vehicle is made of inedible parts, some of which are hazardous or toxic.**

Things you should know

For maintenance interventions, assistance, technical and non-technical consultancy, contact a **VENT Dealer**. They will provide you with accurate, friendly, up-to-date service in accordance with **VENT's** specific guidelines for your vehicle.

Maintenance has been purposefully divided in two specific sheets

The **FIRST SHEET** refers to scheduled maintenance, for users willing to do maintenance themselves. This sheet is called:

INTERVENTIONS TO BE MADE BY A VENT DEALER (BUT CAN ALSO BE CARRIED OUT BY THE USER).

⚠ DANGER ⚠

VENT refuses all liability, both civil and criminal, for damage inflicted to people and things deriving from maintenance interventions carried out by the user.

The user must inform the **VENT Dealer** of the maintenance operations carried out, so as not to have them done twice.

Users unwilling or unable to carry out maintenance operations themselves should contact a **VENT Dealer**.

Even when the user has carried out all maintenance operations, **VENT** advises a road test at a **VENT Dealer**.

The **SECOND SHEET** for scheduled maintenance, for the exclusive use of **VENT Dealers**, is called:

INTERVENTIONS TO BE CARRIED OUT EXCLUSIVELY BY VENT Dealers.

The maintenance operations described in this sheet require technical and updated knowledge, and sometimes specific equipment, only **VENT Dealers** possess.

⚠ DANGER ⚠

Do not attempt to carry out and do NOT have third parties carry out the operations indicated in this sheet, as they may result in damage to the vehicle.

NOTE: *Carrying out schedule maintenance operations does not mean you can forgo the general check you should always perform before using the vehicle.*

Scheduled maintenance sheets

FIRST SCHEDULED MAINTENANCE SHEET.

INTERVENTIONS TO BE CARRIED OUT BY THE **VENT** Dealer (BUT CAN ALSO BE CARRIED OUT BY THE USER)

Key

- ① = check.
- ② = clean.
- ③ = replace.
- ④ = adjust.
- ⑤ = lubricate.

NOTE: Carry out these procedures more frequently if the vehicle is used in rainy or dusty places, or in irregular roads.

(*) = Every 12 months: ③.

(**) = Each tyre replacement ④.

(***) = First replacement after 500 Km then after each 2000 Km.

Components	End of break-in 500 km (312 miles)	Every 2,500 km (1,560 miles) or 6 months	Every 5,000 km (3,120 mi) or 12 months
Spark plug	① ②	Every 1,000 km (625 miles): ② / Every 2,500 km (1,560 miles): ③	
Clutch command/ Clutch play	① ④	① ④	---
Air filter	① ②	① ②	③
Handlebar play	① ④	① ④	---
Swingarm fulcrum axis play/levers (where present)	①	①	---
Lights system	①	①	---
Cooling fluid	①	①	---
Engine oil	③ (***)	③	---
Engine oil filter	③	---	① ③
Engine idling speed	① ④	① ④	---
Wheel rims and spokes	① (**)	① (**)	---
Tyres	①	①	---
Tyre pressure	① ④	① ④	---
Transmission chain tension and lubrication	Every 500 km (312 mi): ① ③ ④		
Swingarm protection skid and chain eye	①	① ③	① ③
Kickstand	---	---	①
Wearing of front and rear brake linings	---	① ③	---

SECOND SCHEDULED MAINTENANCE SHEET.

INTERVENTIONS TO BE CARRIED OUT EXCLUSIVELY BY THE **VENT Dealer**

Key

- ① = check.
- ② = clean.
- ③ = replace.
- ④ = adjust.
- ⑤ = lubricate.

NOTE: Carry out these procedures more frequently if the vehicle is used in rainy or dusty places, or in irregular roads.

(*) = Every 12 months: ③.

(**) = Each tyre replacement ④.

Components	End of break-in 500 km (312 miles)	Every 2,500 km (1,560 miles) or 6 months	Every 5,000 km (3,120 mi) or 12 months
Rear damper	---	①	---
Transmission cables and commands	① ⑤	① ⑤	---
Wheel centring and spoke tension	④	④	④
Handlebar stem bearings and handlebar play	①	①	---
Wheel bearings	---	①	①
Brake disks	①	① ③	---
General functioning of the vehicle	①	①	---
Brake fluid	①	Every year: ③	
Cooling fluid	①	Every 2 years: ③	
Valve play	---	---	① ④
Bolt tightening	①	①	---
Final transmission (chain, crown, pinion)	① ② ④ ⑤	① ② ④ ⑤	---
Fuel tubes	---	①	Every 4 years: ③
Brake tubes	---	①	Every 4 years: ③
Clutch wear	---	①	---

PARTS REMOVAL

In order to carry out some of the maintenance operations/inspections, it is necessary to remove some parts of the vehicle.

Removing the seat

- Unscrew the screws (1) on the left and right sides of the vehicle and recover the spacers.
- Press the saddle downwards "A" and push it towards the front part of the motorcycle "B".

NOTE: Upon reassembly, the tabs (3) must be positioned internally to the side wall in contact with the supports (4).

- To reassemble the saddle (2), lean it on the vehicle, then press it downwards and push it towards the rear part until complete stoppage.

NOTE: The seat must be hooked correctly with the front (5) and central (6) hooks beneath the seat, with their relative seats (7) and (8) on the vehicle.

- Screw back the screws (1) on both sides of the vehicle.

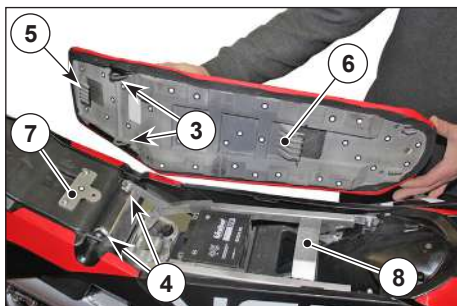
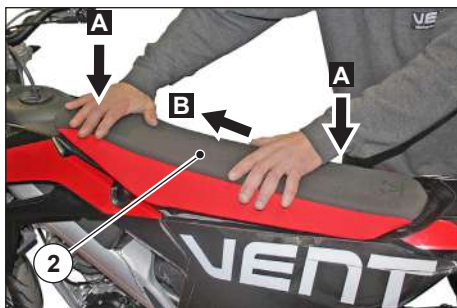
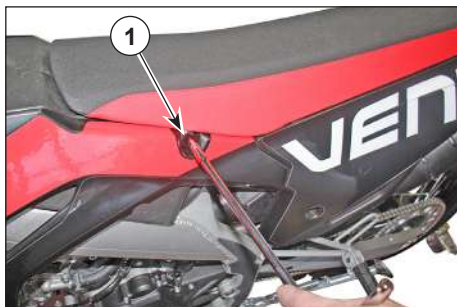

Removing the left front conveyor

- Remove the seat as described in its relative paragraph.
- Undo the screws (1) and collect the socket/spacer from the lower screw (1a).
- Remove the conveyor (2).



Removing the wheels

▲ WARNING ▲

An inexperienced user may find it difficult and complex to disassemble and reassemble the front wheel.

In case of need, contact a VENT Dealer. If you do wish to do it yourself, follow these instructions.

NOTE: When disassembling and reassembling the wheel, be careful not to damage the brake tubes, disk and linings. To disassemble and reassemble, wear work gloves that ensure suitable protection for fingers and hands.

Disassembling the front wheel

- Park the vehicle on the central support kickstand, with the front wheel off the ground.
- Have someone hold the vehicle by keeping the handlebar in its driving position.
- A second operator can now loosen the screw (1) that blocks the wheel pin and unscrew the pin (2).
- Hold the front wheel and manually slide out the wheel pin (2).

▲ WARNING ▲

Mark the spacers and keep them apart so as not to invert their positions when reassembling the wheel.

NOTE: Remove the wheel, carefully sliding the disk from the brake fork.

Remove the wheel by sliding it forward.

▲ WARNING ▲

Do not activate the front brake after removing the wheel, otherwise the fork pistons can leave their seats and cause braking fluid to leak.

If this happens, contact a VENT Dealer.

Reassembling the front wheel

- Have someone hold the vehicle by keeping the handlebar in its driving position.
- Moderately grease the outer seats of the wheel hub.
- A second operator should position the wheel beneath the parts of the fork, inserting the brake disk into the fork.
- Use grease on the wheel pin and slide it completely with the spacer (3) into the wheel hub (left side) and the spacer (4) (right side).
- Tighten the wheel pin (2).

Wheel pin torque: 60 Nm (6 kg/m).

- Remove the central kickstand.
- With the front brake lever activated, press repeatedly on to the handlebar, causing the swingarm to dip. This will allow the swingarm parts to settle appropriately.

- Park the vehicle on its kickstand.
- Tighten the screws (1) of the wheel pin clamp (right side).

Wheel pin clamp screw torque: 10 Nm (1.0 kgm).

▲ DANGER ▲

After reassembling, repeatedly activate the front brake lever and make sure the braking system is functioning properly.

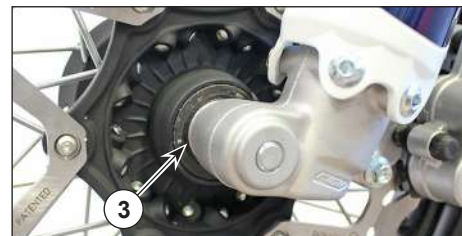
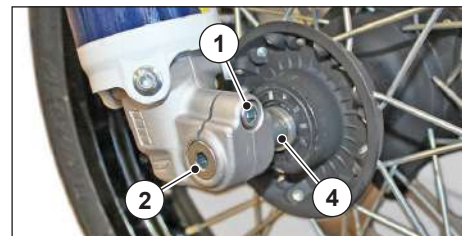

Disassembling the back wheel

- Park the vehicle on the central support kickstand, with the back wheel off the ground.

⚠ WARNING ⚠

Let the engine and the silencer to cool down to room temperature before carrying out any of the next operations, to avoid burns.

When disassembling and reassembling the wheel, be careful not to damage the speed sensor or the brake tubes, disk or linings.

- Have someone support the vehicle.
- A second operator should unscrew the screw nut (1), locking the wheel pin (1) from the other side.

⚠ WARNING ⚠

Mark the spacers and keep them apart so as not to invert their positions when reassembling the wheel.

- Hold the rear wheel and manually slide out the wheel pin (2).
- Remove the wheel towards the back, carefully sliding the disk from the brake fork.

⚠ WARNING ⚠

Do not activate the back brake after removing the wheel, otherwise the fork pistons can leave their seats and cause braking fluid to leak.

If this happens, contact a VENT Dealer.

Reassembling the back wheel

- Moderately grease the outer seats of the wheel hub.
- Make sure the hole (D) of the brake fork support plate (3) is properly inserted in its anti-rotation seat (E), on the inner part of the right arm of the swingarm.
- Apply a small and uniform amount of grease on the wheel pin (2).
- Insert the wheel, careful to centre the disk on the brake fork and not to bump into the speed sensor.
- Assemble the chain on the crown.
- Lift the wheel.
- Insert the wheel pin (2) into the bracket (4) from the left side, assembling its relative spacer (6), and into the bracket (5) from the left side, assembling its relative spacers (7) and (8) (if present).

NOTE: Be careful and insert the brackets (4) e (5) in their relative pins of the chain adjustment screws.

- Lock the pin (2) and tighten the nut (1).

Wheel pin torque: 90 Nm (9 kgm).

NOTE: Make sure tension in the chain is adequate, if necessary.

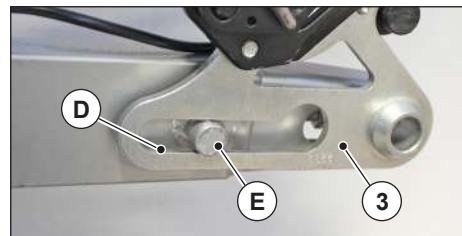
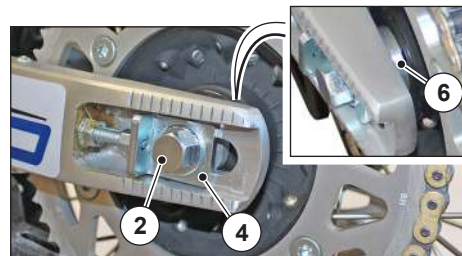
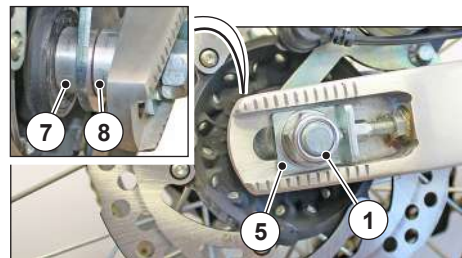

Disassembling the front light holder

- Park the vehicle on its kickstand.
- Unscrew and remove the screw (1). Repeat the operation on the other side of the vehicle.
- Extract the light holder (2) "A" and raise it "B" to unhook it from the seats (3) of the front mudguard.

⚠ WARNING ⚠

The lamp bracket, complete with front headlight, remains connected to the electric cables.

DO NOT FORCE THE ELECTRIC CABLES.

- Disconnect the electric connector (5) from the light cable.

NOTE: Place the lamp bracket on a clean, soft cloth on a support surface, to avoid damage to the bracket.

- Re-mount everything, proceeding in the opposite order to disassembly.

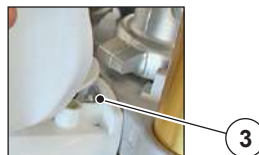
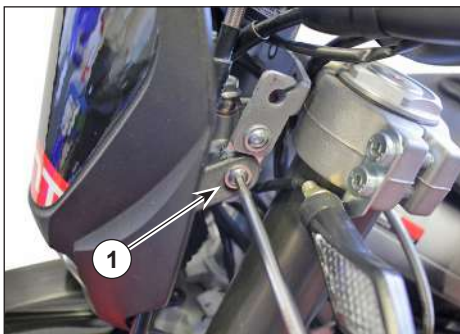
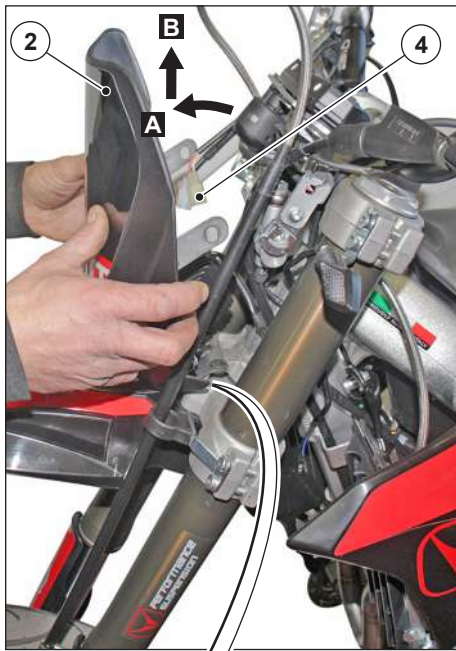

CHECKS

Engine oil level check

NOTE: The engine must be warmed up; the check must be made after a trip or after 5 km (3 miles) in roads outside the city, sufficient to take oil temperature up.

- Park the vehicle on its kickstand.
- Stop the engine and let it cool down for at least 10 minutes, to allow the oil to drain into the housing and the oil itself to cool down.
- Keep the vehicle in the upright position, with both wheels touching the ground.
- Unscrew and remove the dipstick (1), complete with its sealing ring (2).

⚠ WARNING ⚠

Check the sealing ring (2) for wear. Replace it if necessary.

- Use a clean cloth to clean the part that comes into contact with the oil. Insert the dipstick (1) completely in its seat (3), without screwing it.
- Remove the dipstick (1) once again and read the level visible on the stick:
MAX = maximum level
MIN = minimum level
- If the level visible on the stick is around the MAX notch, it is correct.

⚠ WARNING ⚠

Do not fill over the MAX notch or below the MIN notch, to avoid serious damage to the engine.

- If necessary, fill up.
- Pour small amounts of oil into the oil compartment (2) and wait about a minute before pouring some more. Do this until the oil is flowing uniformly within the housing.
- Check the oil level and continue filling up if necessary.
- Screw and tighten the dipstick (1), complete with its sealing ring (2).

Dipstick (1) torque: 7 Nm (0.7 kg/m).

⚠ WARNING ⚠

Tighten the caps well and make sure no oil is coming out.

Periodically check for oil leaks around the housing lid seal.

NOTE: For instructions on changing the oil and the filter, contact a VENT dealer.

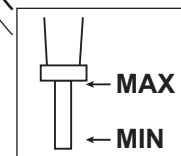
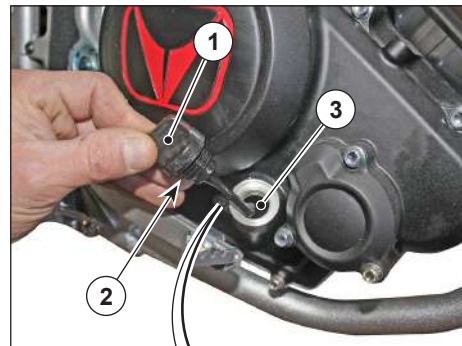

Brake fluid level check

▲ DANGER ▲

Unexpected variations in the brake lever play or elastic resistance on the brake lever are caused by issues in the hydraulic system.

If normal inspections cannot be carried out, or if you are in doubt regarding the perfect functioning of the braking system, contact a VENT Dealer, which will be ready to provide you with accurate, friendly service.

▲ DANGER ▲

Be particularly sure that the brake disk is not greasy or oily, especially after carrying out maintenance or inspections. Make sure the brake tube is not twisted, worn or cracked, cut or fissured in any way.

NOTE: As the friction linings get worn, the level of fluid inside the reservoir diminishes, to automatically compensate the wearing.

Front brake fluid level check

- Park the vehicle on its kickstand.
- Rotate the vehicle completely to the right, so that the fluid contained in the reservoir (1) is parallel with the edge of the reservoir.
- Make sure the level contained in the reservoir is above the MIN notch.

MIN = minimum level (Half of the inspection hatch)

- If the fluid is not at or above the MIN level and the brake linings are not yet to be replaced, fill up the reservoir.

▲ DANGER ▲

For brake fluid top-up, contact a VENT dealer.

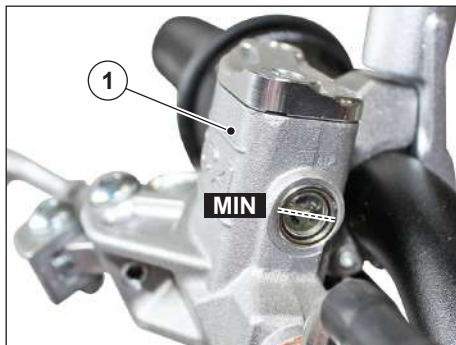
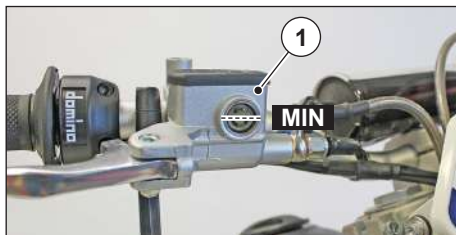

Rear brake fluid level check

- Have someone hold the vehicle in its upright position, so that the fluid contained in the reservoir (1) is parallel with the edge of the reservoir.
- Make sure the level contained in the reservoir is above the MIN notch. MIN = minimum level (Half of the inspection hatch)
- If the fluid is not at or above the MIN level and the brake linings are not yet to be replaced, fill up the reservoir.

▲ DANGER ▲

For brake fluid top-up, contact a VENT dealer.

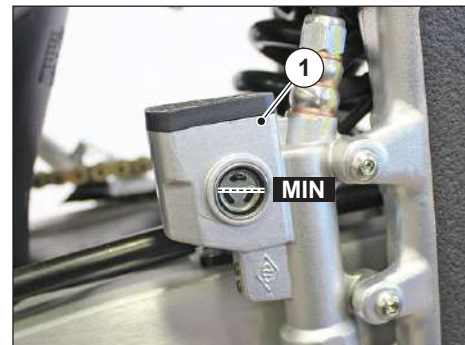

Brake lining check

- Park the vehicle on its kickstand.

NOTE: The brake fork comes with two brake linings.

Visually inspect the area between brake fork and linings, as follows:

- From above and from the front, for the front brake fork (1);
- From above and from the back, for the rear brake fork (2).

⚠ WARNING ⚠

If the friction material is worn beyond acceptable limits, the metal support of the lining might come into contact with the disk, resulting in a metallic noise and the formation of sparks against the fork. The braking effectiveness, the safety and the integrity of the disk would therefore be compromised.

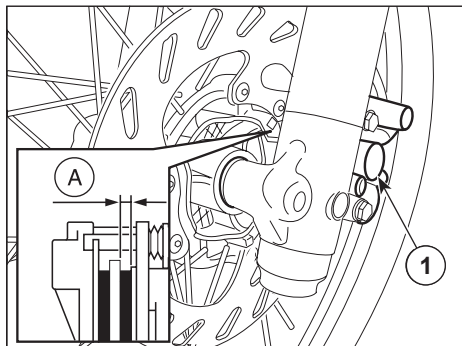

- If the thickness of the friction material (A) (even if considering only one lining, either front or back) drops to about 1.5 mm (or even if only one of the wearing indicators is no longer visible), it is necessary to replace both linings.

⚠ DANGER ⚠

If this happens, contact a VENT Dealer.

Cooling fluid level check

⚠ DANGER ⚠

While the engine is warm, the cooling fluid is under pressure and at a high temperature.

Risk of burns on the skin and damage to clothes.

Remove the cap (1) ONLY after the engine has cooled down to room temperature.

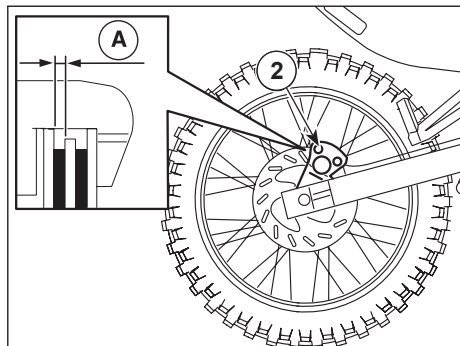

- Switch the engine off and wait until it cools down.
- Keep the vehicle in the upright position, with both wheels touching the ground.
- Turn the handlebar to the left.
- Unscrew (A) (counter-clockwise) the cap (1) until it locks into place (one-fourth of a turn).

Wait a few seconds to allow any remaining pressure to be released.

- Press the cap (1) downwards (B), unscrew it completely (C) (counter-clockwise) and remove it (D).
- Make sure the cooling fluid reaches its maximum level (2). If the level is not reached, top it up without exceeding the maximum level (2).
- Replace and tighten the cap (1).

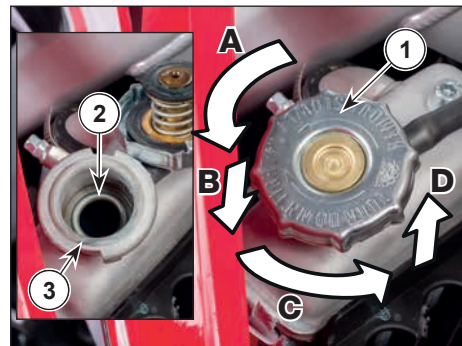

Checking the tyres

Check the status of all tyres, which must not present fissures, abrasions etc. In addition, check the tread for wear, using the indicators on the tyres themselves.

Minimum tread height:

Baja - Baja RR = 4 mm

Derapage - Derapage RR = 2 mm

- Check the pressure while the tyres are at room temperature, and follow the indications on the "Technical information" paragraph.

⚠ WARNING ⚠

The front and rear tyres must be of the same make and model. Using different types of tyres on the same car compromises vehicle stability and manoeuvrability.

NOTE: Tyres get old even if they do not look worn. Side cracks or deformations on the carcass are signs of ageing; have a tyre repairer check your tyres before using the vehicle.

⚠ WARNING ⚠

Riding the motorbike with tyres filled with an incorrect pressure or with worn or deteriorated tyres may cause serious injuries and even death after losing control of the vehicle.

INSPECTIONS AND REGULATIONS

Side kickstand.

- Make sure the springs (1) are not damaged, worn, rusted or weakened. The kickstand must be free to rotate. Grease its joint (2) if necessary.
- Check the two little rubbers (3) that work as limit switches for wear, in the case of motorbikes equipped with passenger footrests.

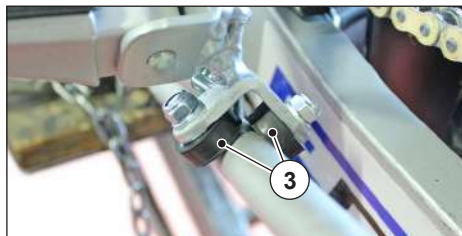
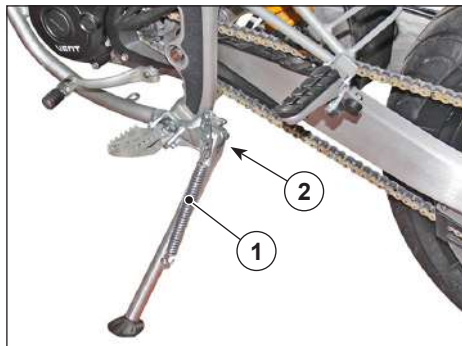

Handlebar

Check the rotation

The handlebar has bearings that allow for minimum play, which must be inspected periodically.

- Climb on to the vehicle, to the pilot position.
- Rotate the handlebar completely to both directions.

NOTE: Make sure the handlebar can rotate in a fluid manner, without obstacles or noises.

The handlebar must be neither too hard nor too loose.

⚠ DANGER ⚠

If you detect any functional anomaly or if specialised intervention is required, contact a VENT Dealer.

Checking the play

- Park the vehicle on the central support kickstand, with the front wheel off the ground.
- Have someone else keep the motorbike still on the central kickstand, while the other operator moderately shakes the limber in the direction of the movement (A).

⚠ DANGER ⚠

If the play detected is evident, contact a VENT Dealer.

- Remove the central kickstand.

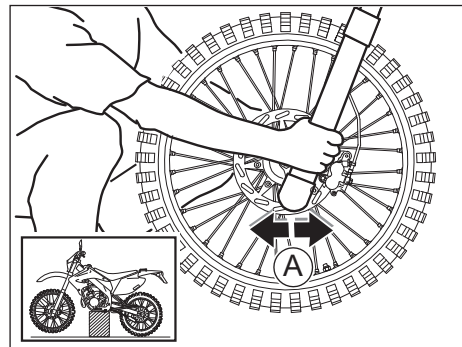

Swingarm

- Park the vehicle on the central support kickstand, with the back wheel off the ground.
- Have someone else keep the motorbike still on the central kickstand, while the other operator moderately shakes the limber sideways (transversal do the direction of the movement) (B).

▲ DANGER ▲

If the play detected is evident, contact a VENT Dealer.

- Remove the central kickstand.

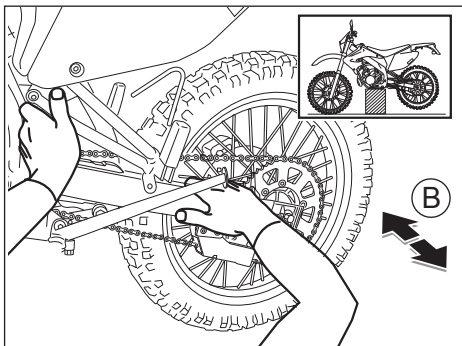

Fuel tank cap

If the orifice on the fuel tank cap is obstructed, fuel aspiration may be compromised, which would hamper the start and the performance of your vehicle.

Periodically check the status of the fuel tank cap.

- Park the vehicle on its kickstand.
- Unscrew and remove the fuel tank cap (1).
- Check the status of the seal (2) on the fuel cap.
If the seal is worn, replace the fuel cap.

▲ DANGER ▲

DO NOT use your mouth to check air passage through the orifice on the fuel tank cap.

- Check the orifices (3) on the fuel cap.
If the orifices are obstructed, clean them with compressed air.
- If cleaning is not enough, replace the fuel tank cap.

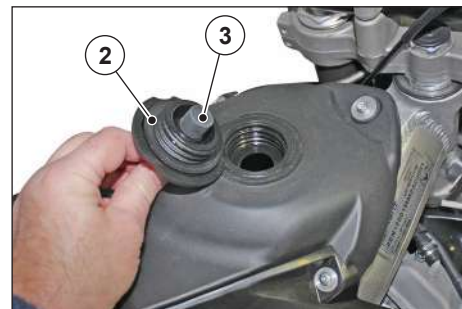
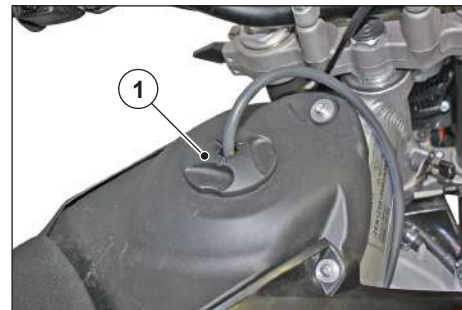

Air filter

▲ **WARNING** ▲

Do not wash or damp the filtration element. **DO NOT** use woollen cloths or any other “furry” material, to avoid leaving residues on the air filter. Do not use screwdrivers or any other tools on the filter.

- Remove the saddle as described in the respective paragraph.
 - Remove the battery as described in the respective paragraph.
 - Undo the screw (1) of the side panel (2).
 - Push the side panel (2) towards the rear part of the vehicle until unhooking it from its seat.
- Remove the side panel located on the opposite side in the same way.

NOTE: Upon reassembly, insert the hook (3) into its specific seat (4) of the tail and the flaps (5) into the specific joints of the conveyor (6), then push the side panel towards the front part of the vehicle.

- Detach the two silencers (7) from the cover frame (8) by unscrewing the screws (9).
- Disconnect the wiring of the direction indicators and of the rear light.
- Loosen the throttle body filter box connection tie-wrap (10).

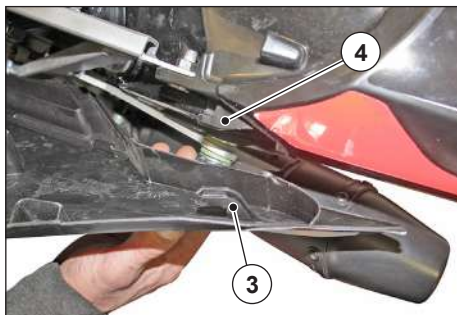
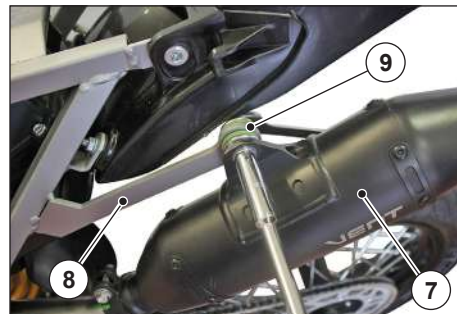
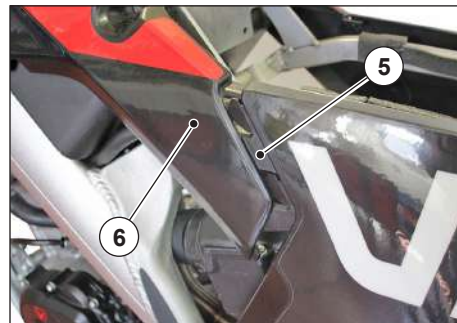
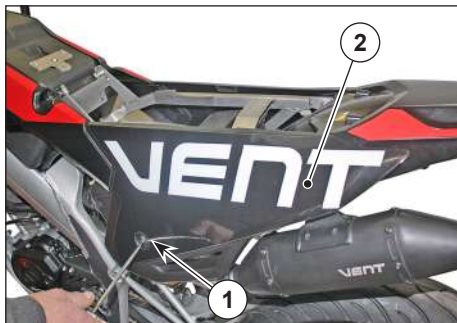

- Disconnect the pipe (11) of the canister.
- Unscrew and remove the cover frame (8) upper support pin (12).
- Unscrew, on both sides, the lower screw (13) of the passenger footplate and the exhaust tube support screw (14).
- Remove the cover frame (8) complete of tail (15) and filter box (16) towards the rear part.
- Undo the fixing screws (17) and (18) of the filter box to the cover frame.
- Extract the filter box (16) from the cover frame (8).

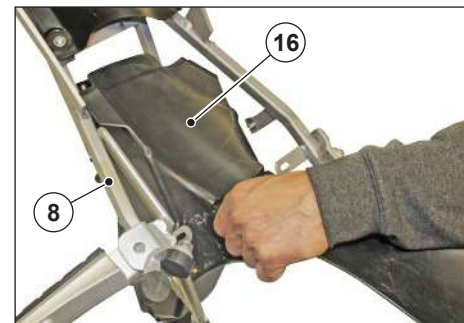
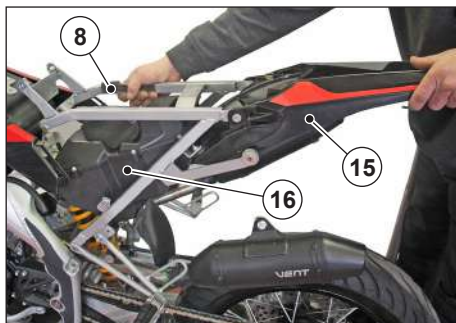
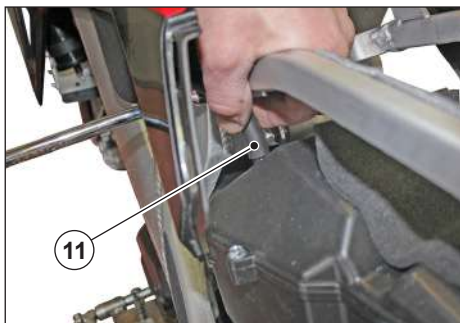
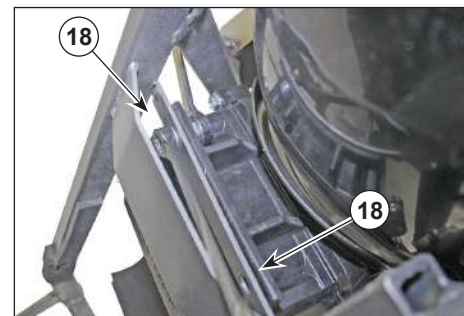
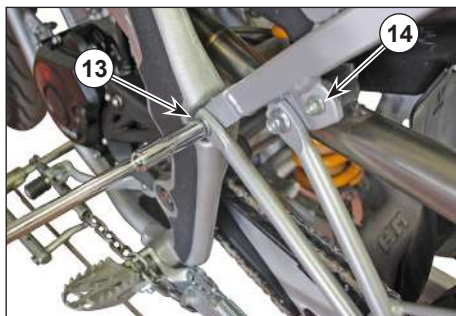
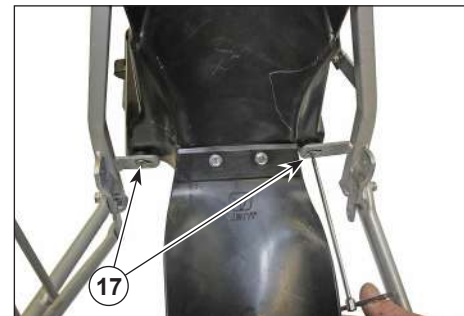
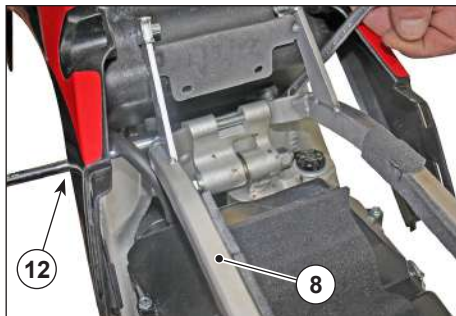

- Undo the screws (19) and remove the filter box lid (20).
- Remove the filter (21) from its specific seat.
- Hold the air filter firmly and hit it several times against a clean cloth.
- If necessary, clean the air filter with compressed air (make the air blow from the inside towards the outside of the filter).
- Clean the outer part of the filter with a clean cloth.

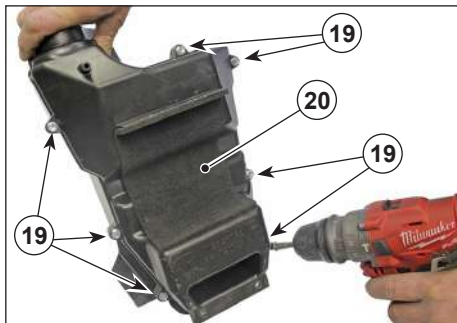

NOTE: While cleaning the filtration element, check it for lacerations. If lacerated, replace it with one of the same kind.

- Use a cloth to clean the inside of the filter box.



⚠ WARNING ⚠
Do not apply oil or anything else on the air filter.

- Reassemble every proceeding in the opposite direction with respect to disassembly.

Transmission chain

NOTE: The vehicle is equipped with a chain of the chain link type. When disassembling and reassembling the chain, make sure the spring (1) of the chain link is installed with its open part turned to the opposite direction of the forward movement (A).

▲ WARNING ▲

If the chain is too loose, it may slip out of its pinion or crown, causing serious accidents or damage to the vehicle.

Periodically check the play "B" and, if necessary, adjust it.

To replace the chain of the pinion and the crown, go to a VENT Dealer, where accurate service will be provided.

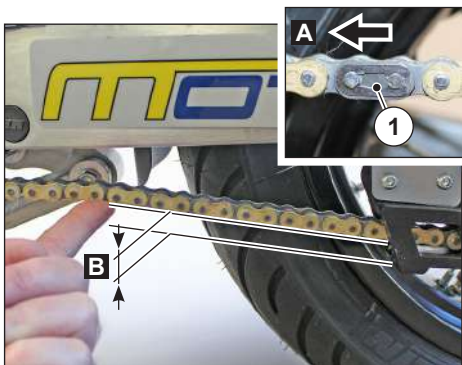

▲ WARNING ▲

Improper maintenance may cause early wear of the chain and/or damage the pinion and/or the crown.

Carry out maintenance interventions more often if you use the vehicle in severe conditions or on dusty/muddy roads.

Check the following parts and make sure the chain, the pinion and the crown do not present:

- Damaged rolls;
- Loose pins;
- Dry, rusted, smashed or jammed links;
- Excessive wear;
- Missing sealing rings;
- Excessively worn or damaged pinion or crown teeth.

▲ WARNING ▲

If the chain rolls are damaged, the pins are loose and/or the sealing rings are damaged or missing, replace the entire chain (pinion, crown and chain).

Wear thresholds for the components

Component	Wear thresholds
Swingarm protection skid (2).	Complete wear of the sliding track.
Chain eye (3).	Complete wear of the sliding track
Upper roll (4), lower roll (5).	Outer diameter of the roll, minimum 27 mm.

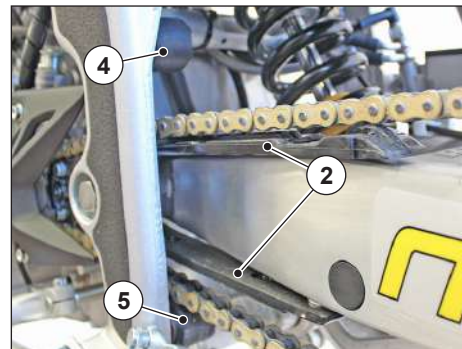

Lubrication and cleaning

NOTE: Lubricate the chain frequently, especially if you find any parts that are dry or rusty. Smashed or jammed links must be lubricated and returned to proper work conditions.

If this is not possible, contact a **VENT Dealer** to have them replaced.

Never wash the chain with water jets, steam jets, high-pressure water, and never use highly flammable solvents.

- Clean the chain with special detergents for OR-ring chains, then dry it with a clean cloth.
- Lubricate the chain with a suitable spray lubricant for OR-ring chains.

⚠ WARNING ⚠

Never use grease to lubricate the chain. Grease causes dust and mud build-ups that work like abrasives, resulting in quick wear of the chain, pinion and crown.

Play inspection.

- Turn off the engine.
- Park the vehicle on its kickstand.
- Place the gear lever in its neutral position.
- Make sure the vertical oscillation (B), in an intermediate point between pinion and

crown in the lower branch of the chain, is of about 40 mm.

- Move the vehicle forward in order to check the vertical oscillation of the chain in other positions as well; the play must remain constant in all the phases of wheel rotation.
- If the play is uniform, but above or below 40 mm, adjust it.

Chain tension regulation

- Loosen the wheel nut (1), locking the wheel pin (2) from the other side.

NOTE: For the centring of the back wheel, there are reference notches (C) printed on both tips of the swingarm arms.

- Loosen the right (3) and left (4) locknuts.
- Work on the right (5) and left (6) chain adjusters to regulate chain play. Make sure the same references are used on both sides of the vehicle.

⚠ WARNING ⚠

On both sides of the vehicle, make sure that the seat (D) present on the bracket is properly coupled with the pin (E) present at the head of the chain adjuster.

- Tighten the right (3) and left (4) locknuts.
- Tighten the wheel nut (1), locking the wheel pin (2) from the other side.

Wheel nut (1) torque: 90 Nm (9 kg/m).

- Check chain play.

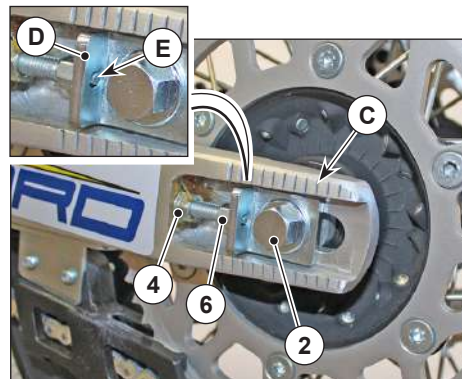
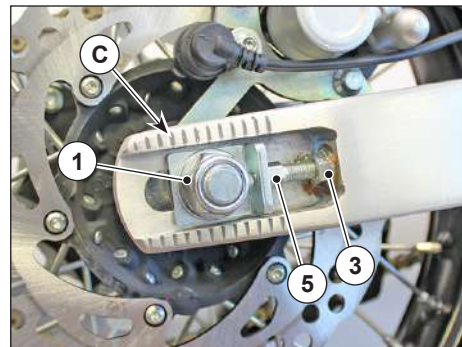

Front suspension

- With the front brake lever activated, press repeatedly on to the handlebar, causing the swingarm to dip. The stroke must be smooth and no traces of oil must remain on the rods.
- Make sure all parts of the front suspension are tightened.

⚠ **WARNING** ⚠

If you detect any functional anomaly or if specialised intervention is required, contact a VENT dealer.

Front suspension adjustment

- Both rods of the front suspension are equipped with adjustment; on the right rod it is possible to adjust the spring pre-load, while the rebound can be adjusted on the left rod.

Pre-load adjustment

- Work on the screw (1); turn it towards “+” to increase pre-load; turn it towards “-” to decrease it.
Standard adjustment: 5 turns from all closed.

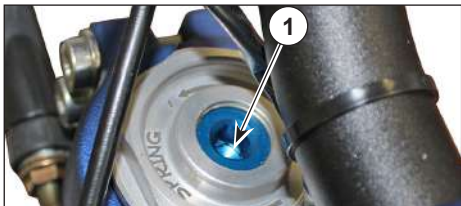

Rebound adjustment

- Work on the screw (2); turn it towards “+” to increase the rebound brake; turn it towards “-” to decrease it.
Standard adjustment: 6 clicks from all closed.



Rear suspension

- Have someone keep the vehicle in its upright position.
- A second operator must hold the rear of the vehicle firmly, pushing it down and releasing it a few times.
A) If the result is:
 - Movement that is not very fluid;
 - Metallic creaking;
 - Perception of play;

⚠ **WARNING** ⚠

Contact a VENT dealer for an inspection.

- Make sure all parts of the rear suspension are tightened.

⚠ **WARNING** ⚠

If you detect any functional anomaly or if specialised intervention is required, contact a VENT dealer.

Spring pre-load rear suspension adjustment.

⚠ **WARNING** ⚠

Possible risk of burns, including serious ones. Before working on the ferule, wait until the engine has completely cooled down, as well as the exhaust silencer.

The basic setting of the suspension is regulated by VENT to fulfil ideal driving conditions [pilot only (weighing around 70 kg)].

For different needs, personalise the setting according to the table below.

Spring pre-load adjustment

⚠ **WARNING** ⚠

Adjust spring pre-load according to the conditions of use of the vehicle.

⚠ **DANGER** ⚠

Sports settings are advised for races or sports events, intended to take place in circuits away from normal road traffic.

- Clean ringnut (1) and adjusting nut (2) of the spring (3).
- Either with a hook wrench or an aluminium punch, loosen the lock ring nut.
- Turn the adjuster ring nut as required.
- When the adjusting operation is over (according to your weight and riding style), tighten the lock ring nut (**coupling torque 50 Nm - 5 Kgm - 36,87 ft/lb**).

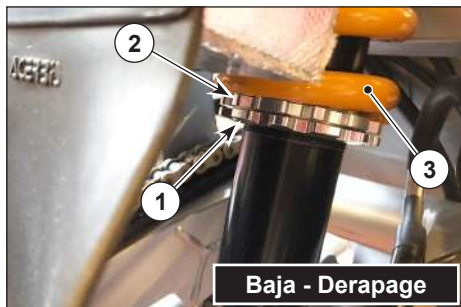

Rebound brake adjustment

- Work on the screw (4).
Tighten the screw to increase rigidity and vice versa.
Standard adjustment: 10 clicks from all closed.

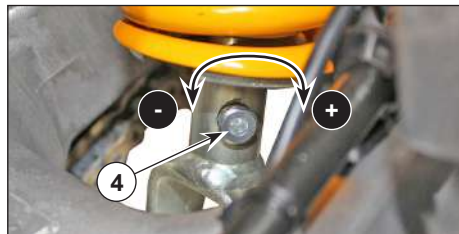

Compression speed adjustment

- Work on the nut (5) to adjust compression speed; rotate the nut (5) towards "S" to obtain a softer compression speed; rotate the nut (5) towards "H" to obtain a "HARDER" compression speed.
Standard adjustment: 15 clicks from all closed.



Spark plug

Periodically disassemble the spark plug, clear it from all carbon residues and replace it if necessary.

▲ WARNING ▲

Before moving on to the next operations, allow the engine and the silencer to cool down to room temperature, to avoid the risk of burns.

- From the right side, remove the boot (1) from the spark plug (2).
- Remove all traces of dirt from the base of the spark plug.
- Unscrew the spark plug (2) and remove it from its seat, being careful not to allow dust or other substances inside the cylinder.

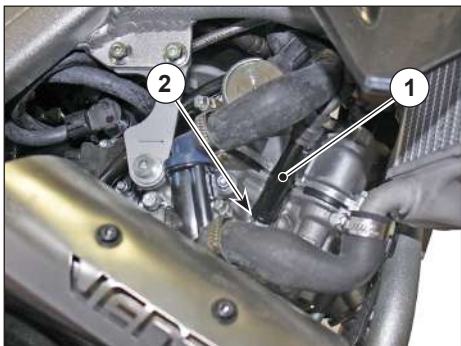

- Make sure the electrodes and the insulation of the spark plug contain no carbon deposits or signs of corrosion. Clean them with compressed air if necessary.

NOTE: *If the spark plug presents cracks on the insulation (4), rusted electrodes (3) and (5), excessive deposits or central electrode (3) with its tip rounded (6), it must be replaced.*

▲ WARNING ▲

When replacing the spark plug, use only new ones of the type advised (see paragraph “Technical information”), otherwise engine performance and duration may suffer.



- Check the distance between the electrodes using a thickness gauge. The distance between the electrodes (1) must be 0.8 mm. Adjust it if necessary, carefully bending the side electrode (5).
- Make sure the washer (7) is in good conditions.
- To reassemble the spark plug, screw it gradually all the way to the limit switch, to avoid damaging its thread.
- Use a wrench to tighten it; turn 1/2 for the plug to compress the washer.

Spark plug coupling torque: 23 Nm (2.3 kg/m).

- Insert the boot (1) correctly in the spark plug (2) until you hear a click.

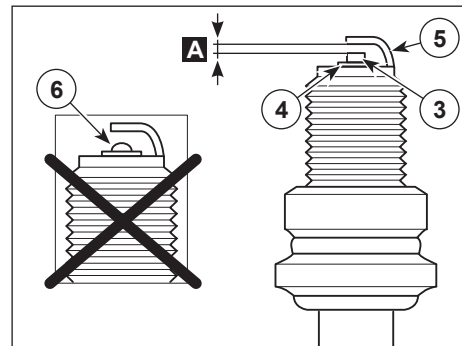

Front brake command lever

The lever is ergonomically positioned during vehicle assembly.

- The position of the lever on the handlebar can be adjusted downwards or upwards by loosening the two fixing screws (1). On reaching the desired tension, tighten the screws (1).

If necessary, lever play can be adjusted as well.

NOTE: Play and strike are directly proportional. When play is increased, so is the strike, and vice versa.

- To adjust play, use the grub screw on the front brake command lever (2).
- For the regulation, loosen the nut (3).

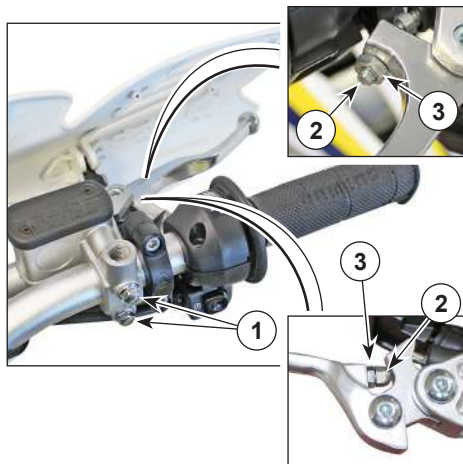

To increase play:

Loosen the grub screw (2).

To reduce play:

Tighten the grub screw (2).

- After regulation, keep the grub screw (2) in position and tighten the nut (3).

⚠ DANGER ⚠

After regulation, make sure the wheel turns freely when the brake is released. Check the brakes for effectiveness. In case of need, contact a VENT Dealer.

Combined braking command lever

The brake lever is ergonomically positioned during vehicle assembly.

NOTE: The play of the rear brake command lever cannot be adjusted.

If necessary, it is possible to personalise the height of the brake lever.

- Park the vehicle on its kickstand.
- Loosen the locknut (1).
- Screw or unscrew the pump command rod (2) using the nut (3) until you obtain the desired brake command lever height.

⚠ DANGER ⚠

DO NOT unscrew the pump command rod (2) completely.

Make sure the pump command rod (2) is always visible within the swingarm (4).

If necessary, screw again the pump command rod (2).

- Keep the pump command rod (2) in position and tighten the locknut (3).

⚠ DANGER ⚠

After regulation, make sure the wheel turns freely when the brake is released. Check the brakes for effectiveness.

In case of need, contact a VENT Dealer.

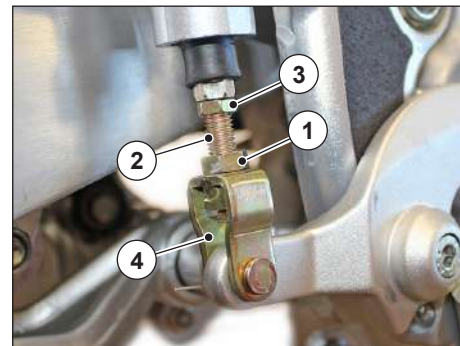

Clutch command lever

The lever is ergonomically positioned during vehicle assembly.

Adjusting the position

The position of the clutch lever on the handlebar can be adjusted downwards or upwards by loosening the fixating screws (1). On reaching the desired tension, tighten the screws (1).

Clutch regulation

Adjust the clutch if:

- When the clutch lever is activated and a gear is inserted, the vehicle moves forwards (the clutch does not detach);
- During acceleration, the engine improperly increases the rotations per minute and there is a delay in the transferring of motion to the rear wheel (the clutch is jammed and, as a consequence, skids).

Proceed as follows to adjust:

- Park the vehicle on its kickstand.
- Move away the protection casing (2).
- Loosen the ferrule (3).
- Rotate the grub screw (4) until the empty strike (A) of the clutch lever, controlled at the tip of the lever, is about **3-4 mm**.
- Keep the grub screw in position (4) and tighten the ferrule (3), locking the grub screw (4).
- Replace the protection casing (2).

Checking for proper regulation

- Start the engine.
- Completely activate the clutch lever, insert the first gear and make sure when the clutch lever is released, the vehicle moves fluidly, without presenting any of the defects described above.

⚠ WARNING ⚠

If it is not possible to obtain proper clutch regulation or if the clutch is working irregularly, contact a VENT Dealer.

NOTE: Check the integrity of the clutch cable all over its length. The sheath must not present fissures, cuts, squashed points or signs of wear. If even one of these defects is identified, have the clutch cable replaced by a **VENT dealer**.

- Periodically lubricate the clutch cable with a suitable lubricant.

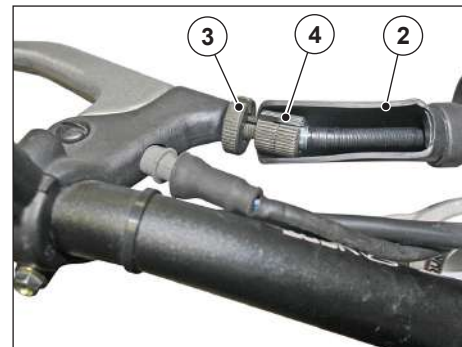
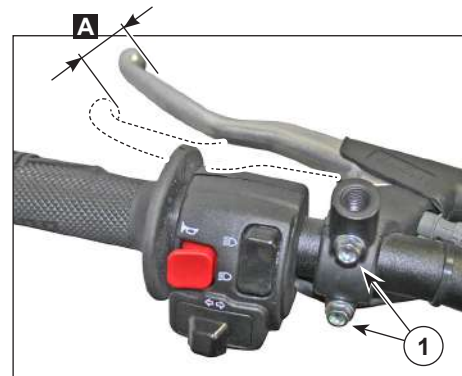

Accelerator command regulation

The empty strike (A) of the accelerator knob must be **2-3 mm**, measured along the edge of the knob itself.

Proceed as follows to adjust:

- Park the vehicle on its kickstand.
- Slide out the protection casing (1).
- Loosen the ferrule (2).
- Rotate the grub screw (3) in order to restore the prescribed value.
- Manually block the rotation of the grub screw (3) and tighten the ferrule (2).
- Check the empty strike (A).

If the outcome is positive:

Replace the protection casing (1).

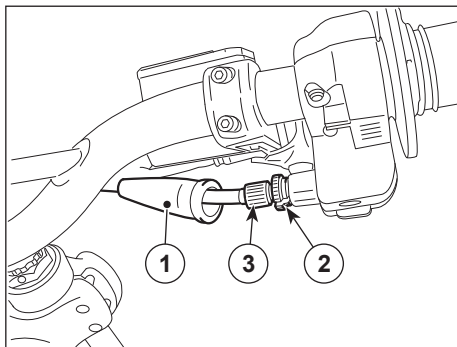
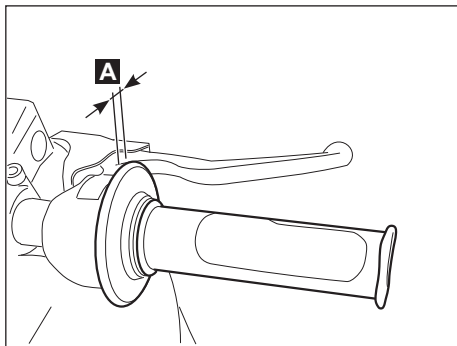

▲ WARNING ▲

After completing the adjustment, make sure the rotation of the handlebar does not hamper the idling speed of the engine and that the accelerator knob, once released, automatically returns to its rest position.

Battery

The vehicle is equipped with no-maintenance battery that does not require checking electrolyte levels.

▲ DANGER ▲

Fire hazard.

Fuel and other flammable substances should never be placed near the electric parts.

Never invert the polarity of the battery cables.

Battery removal

- Place the start switch on **OFF** to avoid accidental short-circuits.
- Remove the seat.
- Unscrew and remove the screw (1) from the negative terminal (-) and move the negative cable (2) to the side.
- Move away the protection casing (3).
- Unscrew and remove the screw (4) from the positive terminal (+) and move the positive cable (5) to the side.
- Firmly grasp the battery (6) and lift it to remove it from its seat.

▲ DANGER ▲

Once removed, the battery must be put in a safe place, away from the reach of children.

Rest the battery on a flat surface, in a cool, dry place.

If the battery needs to be replaced:

- Replace the battery with one of the same type (see paragraph on **Technical Information**).

Reassembling the battery

- Position the master switch at **"OFF"**.
- Position the battery (6) in its seat with the terminals in upper position facing towards the front part of the vehicle.
- Connect the positive clamp (+) using the screw (4).
- Connect the negative clamp (-) using the screw (1).
- Apply neutral grease or Vaseline on the terminals and clamps.
- Replace the protection casings (if applicable).
- Reassemble the seat.

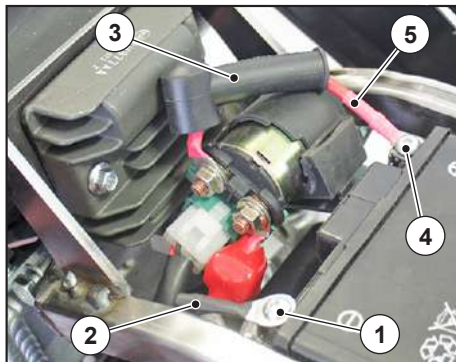

Checking and cleaning the terminals

- With the seat off and the master switch at the **OFF** position.
- Move the safety pads (if applicable).
- Make sure the cable terminals the screw clamps (1) and (4) of the battery are in good conditions (and not corroded or covered in deposits) and that they are covered by neutral grease or Vaseline.

If the inspection proves the ensemble to be ok, reassemble the seat.

If the inspection shows the need for maintenance:

- Remove the battery.
- Brush the cable terminals and the screw terminals (1) and (4) of the battery with a metal brush, to eliminate all traces of rust.
- Reassemble the battery.

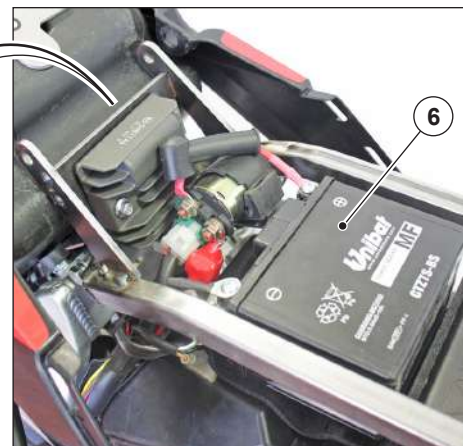

Long battery inactivity

- If the vehicle is to remain inactive for more than a fortnight, the battery will need recharging to keep it from going through a sulphation process.
- During the winter months, or when the vehicle remains unused, to avoid its degradation remove the battery from the vehicle and check its charge periodically (about once a month).
- If the battery remains in the vehicle, disconnect the cables from the clamps.

Recharging the battery

- Remove the battery.
- Provide a suitable battery charger.

⚠ DANGER ⚠

Carefully read the instructions of use for the battery charger.

During recharge, make sure the area is well ventilated and avoid inhaling the fumes released during the recharge.

Prepare the charger for the type of charge desired (see table).

Type of recharge	Voltage V	Tension (A)	Time (hours)
Normal	12	0.6	5-10
Quick	12	3.0	1

- Connect the battery to the charger.
- Turn on the charger.

After the recharging period:

- Unplug the charger.
- Disconnect the battery from the charger.

⚠ DANGER ⚠

Wait about 10 minutes after unplugging the charger before installing the battery, as the battery will release fumes for a short while even after disconnection.

Fuses

⚠ WARNING ⚠

Do not repair defective fuses.

Never use fuses different than those specified.

This might cause damages to the electric system or even fire, in the event of a short-circuit.

NOTE: When a fuse is frequently defective, a short-circuit or an overload is likely to have taken place.

If this happens, contact a **VENT Dealer**.

If an electric part is found to be missing or is working irregularly, or if the engine fails to start, check the fuses.

Control and/or replacement of fuses

⚠ WARNING ⚠

Remove one fuse at a time, to avoid misplacing them.

Make sure the fuse presents:

- intact filament;
- proper assembly.

If the filament is interrupted:

⚠ WARNING ⚠

Before replacing the fuse, if possible, try to identify the problem that caused this inconvenience.

⚠ WARNING ⚠

Replace the fuse, if damaged, with another with the same amperage.

NOTE: If the spare fuse is used, remember to insert an identical one in its seat.

- To access the ignition contactor fuse, remove the saddle as described in the respective paragraph.
- Turn the start switch key to "OFF".
- Remove the lid (A) from the fuse box.

Fuse position

- fuse (1) **10 A**: fan and fan relay;
- fuse (2) **15 A**: pump + injector + coil;
- fuse (3) **7,5 A**: oxygen sensor + solenoid + EODB + start button;
- fuse (4) **10 A**: rear / front lights + horn + dashboard + direction indicators + brakes;
- fuse (5) **20 A**: main fuse;
- fuse (6) **20 A**: Spare fuse.

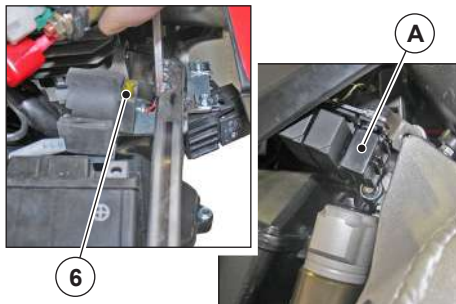

After checking or replacing:

- Replace the fuse in its own seat.
- Correctly replace the components removed to access the fuses.



For a quick check of the proper orientation of the front headlight:

- Place the vehicle on a solid, flat terrain.
- Leave the vehicle 10 metres away from a vertical wall.
- Climb on to the vehicle, to the pilot position.
- Turn the start switch key to "ON".
- Make sure the headlight switch is in the low beam position "D".
- Make sure the light beam projected on the wall is slightly below the horizontal line of the projector (about 9/10 of the total height).
- If necessary, adjust it.

Also check:

- That the light beam is uniform;
- That no shadow areas are present.

Light beam

▲ DANGER ▲

Incorrectly adjusted beams may cause accidents, including serious ones.

NOTE: Based on the laws in force in the Country where the vehicle is used, checks on the orientation of the light beams require specific procedures.

This is the Italian procedure.

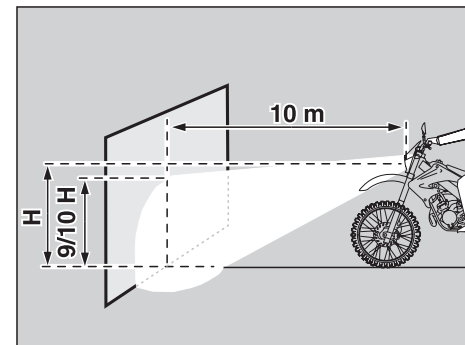
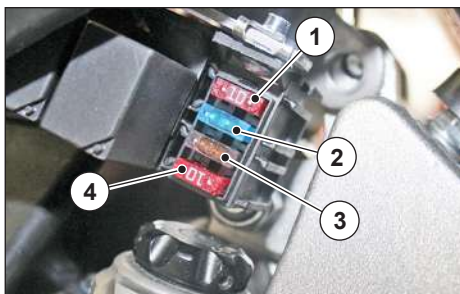

Regulation

- Use a screw driver on the screw (1).
SCREWING (clockwise), the light beam moves **up**.
UNSCREWING (counter-clockwise), the light beam moves **down**.
- Screw or unscrew until you obtain the desired beam height.



Front headlight

Front headlight Model Derapage RR + Baja RR

The front headlight unit is LED. If it is not working, the entire headlight unit must be replaced. For this replacement, contact a **VENT Dealer**.

Front headlight Model Baja - Derapage

The front headlight contains:

- A parking light bulb (1);
- A high beam/low beam light bulb (2).

ACCESS TO THE LIGHT BULBS

Partially remove the front light bracket.

⚠ WARNING ⚠

The lamp bracket, complete with front headlight, remains connected to the electric cables.

DO NOT FORCE THE ELECTRIC CABLES.

Parking light bulb

⚠ WARNING ⚠

To remove the light bracket, do not tug on the power cables.

Disassembly

- Grip the light bracket (3), pull it and remove it from its seat.
- Press the light bulb (1) with moderate strength and turn it counter-clockwise.
- Remove the light bulb (1) from its seat.

Reassembly

- Insert the light bulb in its socket, making sure the two guiding pins match their guides in the socket.
- Insert, press and rotate the bulb (1) clockwise.
- Insert the light bulb socket (3) in the headlight seat.
- Reassemble the front headlight.

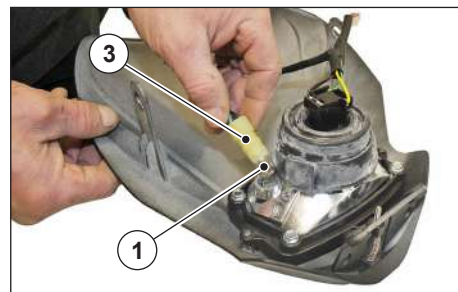

Low beam/high beam light bulb



WARNING



To remove the electric connector, do not tug on the power cables.

Disassembly

- Unhook the connector (4).
- Extract the pad (5) from the light (6).
- Unhook the locking clip (7) of the bulb.
- Extract the bulb (8) from the parable seat.

Reassembly

- Insert the bulb (8) in the parable seat.
- Correctly hook the locking clip (7) to the light.
- Slide the casing (5) properly.
- Insert the connector (4).
- Reassemble the front headlight.

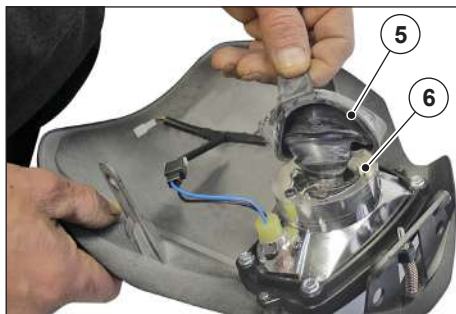

Rear headlight bulb

The rear headlight unit is LED. If it is not working, the entire headlight unit must be replaced. For this replacement, contact a **VENT Dealer**.

Front and rear blinkers

The blinkers are powered by LED. If it is not working, the entire headlight unit must be replaced. For this replacement, contact a **VENT Dealer**.

TRANSPORTATION



DANGER



In the event of a breakdown, do not tow the vehicle yourself. Request a professional towing service.



WARNING



Before loading, remove or anchor to the transportation surface (of the cart or van) all objects that may be displaced during transportation and crash against the vehicle, therefore damaging it.

NOTE: *The height of the transportation surface (of the cart or van) requires the use of a slide that allows for the loading of the vehicle. The size, material and rigidity of the slide must be sufficient to support the weight of the vehicle during loading.*

- While loading the vehicle, get another person to help you.
- Load the vehicle on the cart or van in its normal moving position, with both wheels touching the floor.
- Insert the first gear and anchor the vehicle to the floor by hooking the straps on frame parts, handlebar etc, in such a way as not to ruin plastic parts such as conveyor sides and reservoir.



DANGER



Make sure the vehicle cannot move at all, to ensure its stability during transportation.

CLEANING

Washing

It is advisable to periodically wash the vehicle, to maintain its components in good conditions.



WARNING



Using in the following conditions requires more frequent washing, to protect its components:

- Seaside areas or places with a hot, damp climate, where humidity and saltiness are above average.
- Roads or areas where salt or chemicals are used as anti-freeze.
- Roads or areas with the presence of industrial dust or asphalt spots.
- Sports and off-road use.
- When the body of the vehicle is spotted with dead insects, bird droppings etc.



WARNING



Avoid parking or lounging beneath plants or trees.

During some seasons, certain plants and trees drop or release residues, resin, fruits or leaves containing substances that can damage the vehicle (especially its body).

Washing rules



WARNING



Do not wash the vehicle under the sun, especially during summer, while the body of the vehicle is still hot. If the detergent dries on its surface before it is rinsed away, the painting may be damaged.

To clean the plastic parts of the vehicle, do not use liquids at temperatures above 40° C.

Do not direct air or water at high pressure or steam jets on the following parts:

- Wheel hubs;
- Commands on the left and right sides of the handlebar;
- Bearings;
- Pumps and brake reservoirs;
- Instruments and indicators;
- Opening of the silencer or the exhaust;
- Steering lock;
- Radiator flaps;
- Fuel cap and any other caps;
- Headlights;
- Electrical connections;
- Stickers.

⚠ WARNING ⚠

Do not use alcohol, benzenes or solvents to clean the rubber or plastic parts of the seat. Use only water and a gentle soap.

NOTE: To clean *ONLY* the outer parts of the engine, use a degreasing detergent suitable for motorcycles, brushes and cloths.

⚠ WARNING ⚠

Using high-pressure water jets can ruin parts of the vehicle.

- Use a low-pressure water jet to wet the vehicle and, in particular, its soiled parts.
- Use a soft cloth to rub all parts of the vehicle.
- Use a low-pressure water jet to rinse the vehicle.
- Dry the vehicle with clean shammy leather.

⚠ DANGER ⚠

Washing the vehicle can reduce braking efficiency.

- Dry the disks, then carefully and repeatedly test the brakes.
- Check all brake functions, referring to the specific paragraph.

Polishing

⚠ WARNING ⚠

Only after accurately cleaning the vehicle should you proceed to polishing it with silicone waxes.

Abrasive pastes ruin opaque paints.

⚠ DANGER ⚠

Never apply protective waxes on the seat, as this would make it slippery and therefore dangerous.

STORAGE

Follow the precautions below to avoid the effects deriving from not using the vehicle.

- Completely empty the fuel tank and the carburettor.
- Remove the spark plug.
- Pour a teaspoon (about 5-10 cm³) of two-stroke engine oil into the cylinder, through the spark plug seat.

NOTE: Place a clean cloth on the cylinder, near the spark plug seat, to protect against oil splashes.

- Work on the start lever a few times, to uniformly distribute the oil poured into the cylinder.

- Reassemble the spark plug.
- Remove the battery.
- Wash and dry the vehicle.
- Apply wax on the painted surfaces.
- Check tyre pressure.
- Park the vehicle in a non-heated place, free of dampness, protected against sunlight and with as little temperature variation as possible.
- Wrap a plastic bag around the exhaust outlet or silencer to keep humidity or dirt from entering.

⚠ WARNING ⚠

Whenever a tyre remains in place for too long resting on the ground, its properties are altered.

- Place the vehicle on a support so that both tyres are lifted off the ground.

⚠ WARNING ⚠

Protecting the vehicle from dust will make vehicle parts last longer and facilitate washing when the vehicle is to be used again.

Avoid using plastic or waterproof materials which might cause humidity to accumulate, with consequent deterioration of the parts.

- Cover the vehicle with a tarpaulin (made of cotton, wool or another transpiring material) large enough to fully cover the vehicle, without touching the ground.

When you decide to use the vehicle again:

- Uncover and wash the vehicle.
- Fill its fuel tank.
- Check its functions.

⚠ DANGER ⚠

Ride the vehicle for a few kilometres at a moderate speed, in an area away from heavy traffic.

TECHNICAL SPECIFICATIONS

		Baja	Baja RR	Derapage	Derapage RR
<i>DIMENSIONS</i>	Length (mm)	2200		2130	
	Width (mm)	810			
	Height (at the handlebar) (mm)	1225		1015	
	Height at the seat (mm)	940		900	
	Distance between axis (mm)	1445			
	Minimum free height from the ground (mm)	315		265	
	Empty weight (kg)	110	105	111	108,5
	<i>MOTOR</i>				
Type	Minarelli 4-stroke single-cylinder, liquid-cooled 4 SOHC variable timing valves VVA				
Number of cylinders	Single-cylinder, tipped forward.				
Overall engine capacity	124,66 cm ³				
Boring/stroke	52,0 mm / 58,7 mm.				
Compression ratio	11.2: 1				
Electric	electric				
Engine rotations per minute at idle	1400 ± 150 min-1				
Clutch	oil bath multi-disc				
Cooling	liquid				
Exhaust system	"Black Finish" double silencer				

		Baja	Baja RR	Derapage	Derapage RR
CAPACITY	Fuel (including reserve)	9,5 litres			
	Fuel reserve	2,5 litres	2,5 litres	2,5 litres	2,5 litres
	Engine oil				
	- oil change	950 cm ³			
	- oil change and oil filter	980 cm ³			
	- when disassembling the engine	1050 cm ³			
	Cooling fluid	0,8l (40% water + 60% anti-freeze with ethylene glycol)			
	Seats	2			
	Vehicle load:				
	- Pilot + luggage	90 kg			
- Pilot + passenger + luggage	165 kg				
GEAR	Type	6-gear shift, pedal commend on the left side of the engine.			
TRANSMISSION CHAIN	Size	428			
THROTTLE BODY	Number	1			
	Model	MIKUNI Ø30			
POWER SUPPLY	Fuel	E10 GREEN			

		Baja	Baja RR	Derapage	Derapage RR
FRAME	Material	Steel	Aluminium	Steel	Aluminium
	Type	Double-cradle perimeter with decomposable rear part			
SUSPENSIONS	Front	USD hydraulic fork with fork			
		Ø 41 mm R16V	Ø 41 mm R16V adjustable in preload and extension	Ø 41 mm R16V	Ø 41 mm R16V adjustable in preload and extension
	Travel	260 mm			
	Rear	Hydraulic monoshock with adjusta- ble preload	Hydraulic monoshock adjustable in preload, ex- tension and compression with separa- ted gas tank and leverage HM-link 2,0	Hydraulic monoshock with adjusta- ble preload	Hydraulic monoshock adjustable in preload and extension with separa- ted gas tank and leverage HM-link 2,0
	Travel	240 mm			

		Baja	Baja RR	Derapage	Derapage RR
BRAKES	Front	WAVE disk			
		Ø 260 mm		Ø 290 mm	Ø 300 mm
		Hydraulic transmission			
		Two-pistons floating callipers	Increased two-pistons floating callipers and brake pump BCA	Two-pistons floating callipers	Increased two-pistons floating callipers and brake pump BCA
	Rear	WAVE disk			
		Ø 220 mm			
		Hydraulic transmission			
		Floating callipers	Aluminium increased floating callipers	Floating callipers	Aluminium increased floating callipers
WHEEL RIMS	Type	Aluminium alloy with tangential spokes			
	Front	21"		17"	
	Rear	18"		17"	

		Baja	Baja RR	Derapage	Derapage RR
TYRES	Front	90/90 - 21"		110/70 - 17"	
	Pressure	130 kPa (1,3 bar)		140 kPa (1,4 bar)	
	Rear	120/90 - 18" 120/80 - 18"	120/90 - 18"	140/70 - 17"	
	Pressure	150 kPa (1,5 bar)		150 kPa (1,5 bar)	
START UP	Type	Electronic YAMAHA - 2 PV - 14V - 140W			
SPARK PLUG	Standard	MR8E-9			
LIGHT BULBS	Front parking light	12 V - T4W	LED	12 V - T4W	LED
	Low beam/high beam	12 V - 35/35 W - S2	LED	12 V - 35/35 W - S2	LED
	Front blinkers light	12 V - LED			
	Rear blinkers light	12 V - LED			
	Rear parking light/plate light/stop light	LED unit			

VENT SRL thanks you for choosing one of its products and invites you to:

- Follow the laws of the road;
- avoid leaving the engine on when not necessary;
- avoid making bothersome noises with the vehicle;
- not dispose of oil, fuel and other polluting substances and components in the environment;
- respect nature.

VENT SRL chooses NILS lubricants





VENT

**VENT S.r.l. - Via alla Cascata 5/7
23815 Introbio (LC) - Italy
VAT number: 03728030135 - IT**