

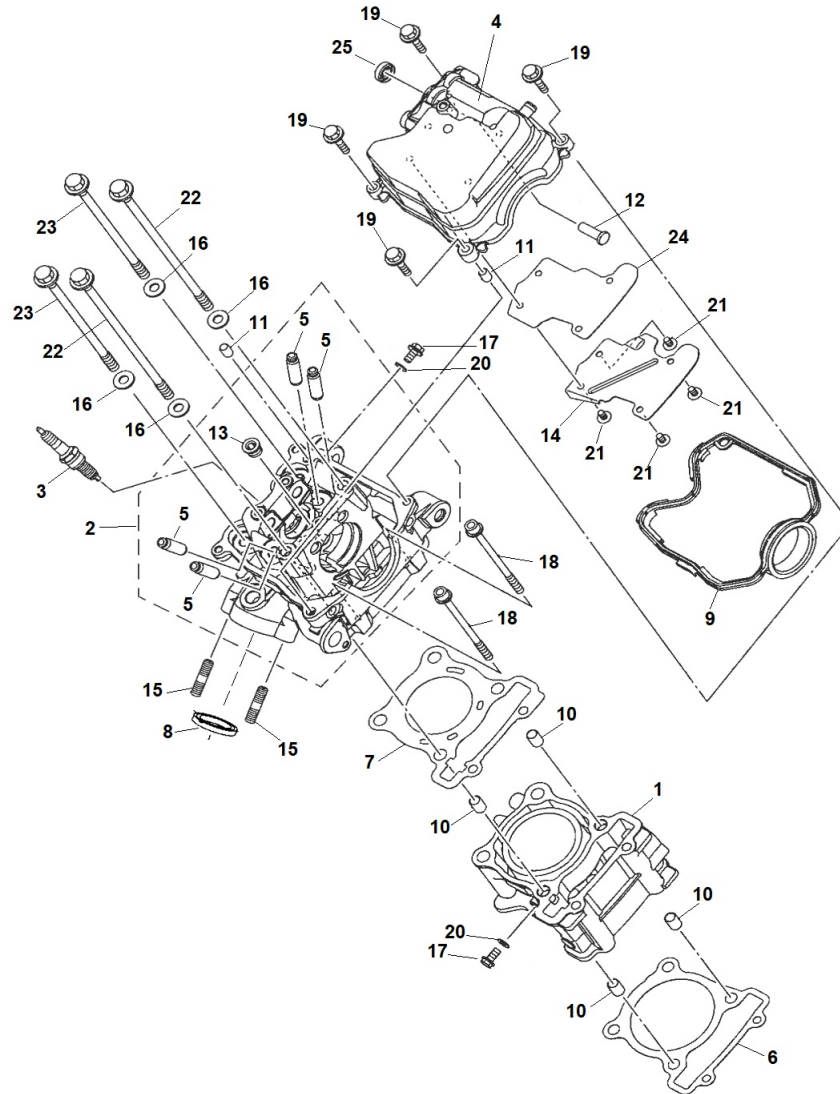



















HEAD-CYLINDER

















HEAD-CYLINDER

N.		Part n°	Description	Notes	Notes	Taxable price (€)
1		2DSE1311	CILINDRO D.52 (MARC.2DS00)			107,92
2		B5GE1102	TESTA COMPLETA			296,32
3		947000043	CANDELA NGK MR8E-9 GAP 0.9			25,40
4		BK6E1191	COPERCHIO SU TESTA			60,83
5		2DPE1133	GUIDA VALVOLA MAGGIORATA			55,71
6		BK6E1351	GUARNIZIONE BASE CILINDRO			18,12
7		2DSE1181	GUARNIZIONE TESTA			13,38
8		BK7E4613	GUARNIZIONE TUBO SCARICO			6,62
9		B3FE1193	GUARNIZIONE COP.TESTA (O-RING)			15,18
10		5602672	GRANO DI RIF.D.10X14-INT.D.8,5			3,38
11		5602670	GRANO RIF. COP.POMPA OLIO 8X12			3,09
12		BK6E132G	PERNO SPINGI BILANCIERI			10,00
13		90340128	TAPPO PER TESTA			6,98
14		BK6E1165	PIASTRA SU COPERCHIO TESTA			15,04
15		95612086	PRIGIONIERO M8x34			3,72
16		90201088	RONDELLA PIANA D.18x8,2x1,6			3,38
17		95E32060	VITE T.E. FLG M6x10 Zn.GIALLA			3,01
18		90110063	VITE T.C.C.E. M6x100 C/RONDELL			4,38
19		9502206030	VITE T.E. FLG. M6x30 Zn.BIANCA			3,09
20		9043006803	RONDELLA ALLUMINIO D.6x11x1			3,01

HEAD-CYLINDER

N.		Part n°	Description	Notes	Notes	Taxable price (€)
21		90149058	VITE T.C.B. M5x8 FISS.PIASTRA			3,97
22		BK6E1361	VITE T.E. FLG. M8x1,25 L=200			6,91
23		BK6E1362	VITE T.E. FLG. M8x1,25 L=155			4,70
24		BK6E1169	GUARNIZIONE PER COPERCHIETTO			26,94
25		9310208800	PARAOLIO D.18x6,8x6			5,26





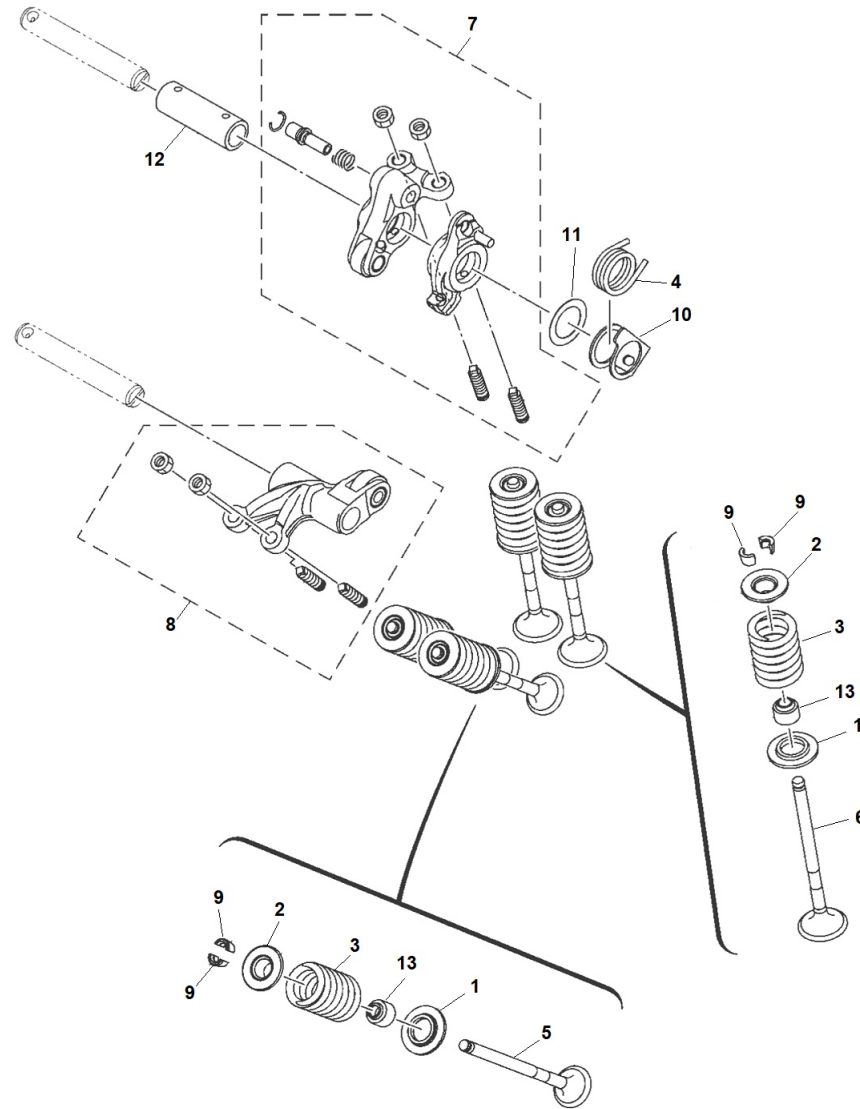

PISTON - CRANKSHAFT

N.		Part n°	Description	Notes	Notes	Taxable price (€)
1		B5GE1631	PISTONE D.52			54,10
2		B5GWE140	IMBIELLAGGIO COMPL. X RICAMBI			383,05
3		B5GE1603	SERIE SEGMENTI D.52			49,10
4		B5GE1454	CONTRALBERO			69,68
5		4005684	INGRANAGGIO CONDUT.CONTRALBERO			76,07
6		4005685	INGRANAGGIO CONDOT.CONTRALBERO			76,07
7		93306305X	CUSCINETTO D.25X62X17			25,87
8		93306203	CUSCINETTO A SFERE D.17x40x12			26,21
9		2DPE1633	SPINOTTO D.14x37,3 FORO D. 9			18,05
10		302247	ANELLO FERNO SPINOTTO D 14			2,04
12		90280030	CHIAVETTA D.13x3x5 PER VOLANO			3,97
13		90170100	DADO M10X1 H=8 CH=19			13,05
14		90215108	RONDELLA 10,2x28x0,8 C/LINGUET			3,72
15		90387158	DISTANZIALE			4,92

VALVES



VALVES

N.		Part n°	Description	Notes	Notes	Taxable price (€)
1		55PE2126	SCODELLINO VALVOLE INFERIORE			9,33
2		2DPE2117	SCODELLINO VALVOLE SUPERIORE			16,02
3		B63E2113	MOLLA VALVOLE			6,84
4		BK6E2226	MOLLA BILANCIERE			7,91
5		B3ME2121	VALVOLA DI SCARICO			27,34
6		BK6E2111	VALVOLA DI ASPIRAZIONE			19,55
7		BK6E2150	BILANCIERE ASPIRAZIONE COMPL.			322,30
8		B5VE2160	BILANCIERE SCARICO COMPLETO			69,38
9		5TLE2118	ANELLO RITEGNO MOLLE			3,75
10		BK6E2279	FERMO MOLLA BILANCIERE			6,62
11		BK6E1557	RONDELLA ONDULATA D.21x15x2,3			3,75
12		BK6E2166	BOCCOLA PERNO BILANCIERE			26,17
13		54PE2119	ANELLO TENUTA D.4,5x10,5x8,2			4,82

CAMSHAFT-CHAIN

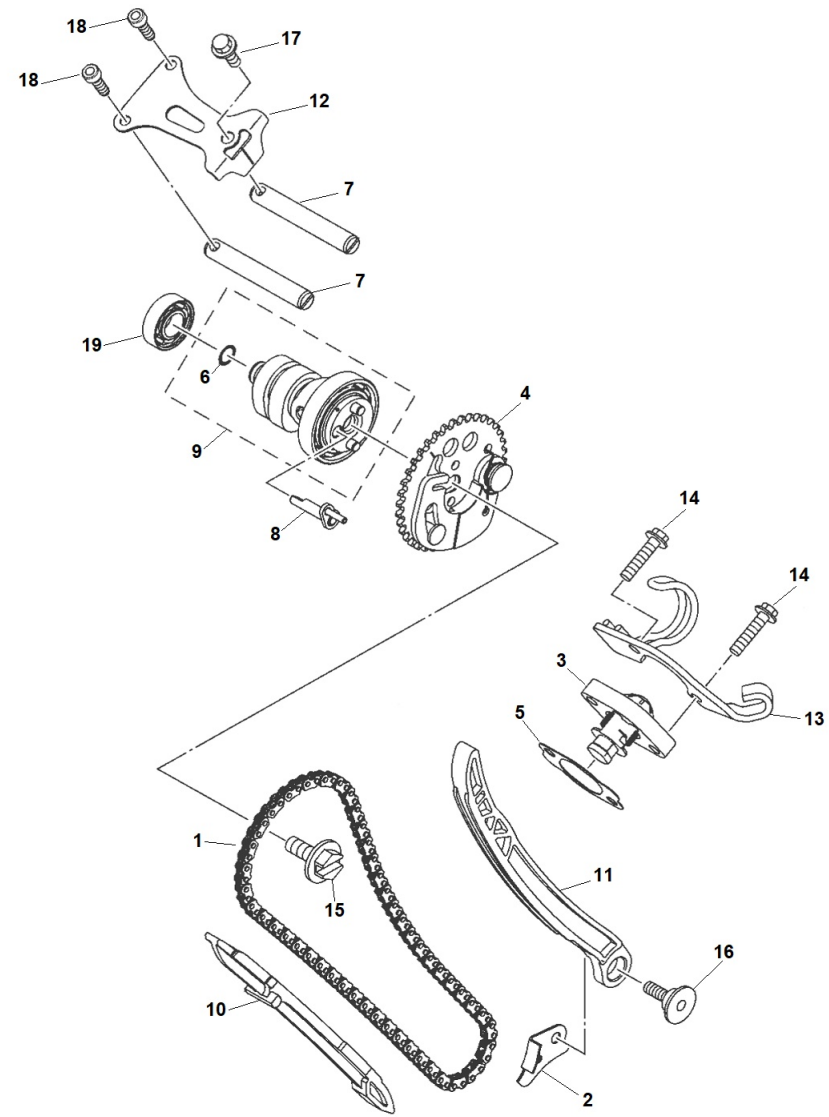

CAMSHAFT-CHAIN

N.		Part n°	Description	Notes	Notes	Taxable price (€)
1		94568J909	CATENA DISTRIBUZIONE			21,43
2		BK6E2256	COPERCHIO COPRICATENA			3,75
3		2NDE2210	TENDITORE PER CATENA			55,31
4		B3ME2280	DECOMPRESSORE			25,40
5		BK6E2213	GUARNIZIONE DEL TENDITORE			3,31
6		93210098	ANELLO DI TENUTA OR D.8,8x1,9			3,01
7		B65E2156	PERNO BILANCIERE			17,93
8		BK6E2288	PERNO/CAMMA PER DECOMPRESSORE			23,08
9		B5GE2170	ALBERO A CAMME COMPLETO			133,70
10		B65E2231	GUIDA CATENA 1			5,55
11		BK6E2241	GUIDA CATENA 2			5,66
12		2DPE111F	PIASTRINA BLOCC.ALBERO CAMME			7,28
13		BK6E5441	PIASTRINA PASSAFILO			10,00
14		95E3206025	VITE T.E. FLG M6x25 Zn.GIALLA			3,09
15		5YPE2157	VITE T.E.FLG M8x1,25 CH=12			5,78
16		54PE2228	VITE T.B.			6,32
17		9502206014	VITE T.E. FLG M6x14 Zn.BIANCA			2,72
18		9131205016	VITE T.C.C.E. M5x16 ZN.BIANCA			3,09
19		93306001Y	CUSCINETTO A SFERE D.12x28x8			22,71







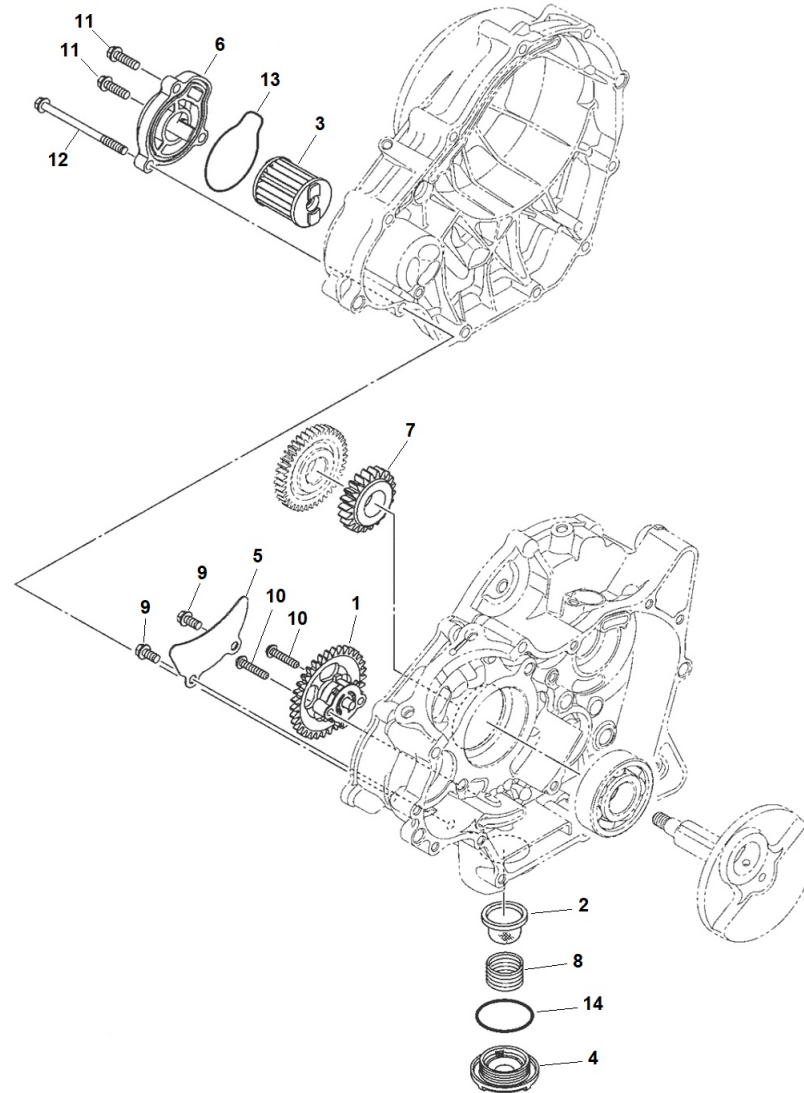







WATER PUMP

N.		Part n°	Description	Notes	Notes	Taxable price (€)
1		BFSE2483	TUBO CIRCUITO RAFFREDDAMENTO			12,27
2		90450278	FASCETTA A VITE X TUBO RAFFR.			4,92
3		2DPE2428	GUARNIZIONE COP.POMPA ACQUA			7,20
4		2DPE2450	PERNO POMPA ACQUA CON GIRANTE			22,12
5		BK6E2410	TERMOSTATO			48,04
6		5602670	GRANO RIF. COP.POMPA OLIO 8X12			3,09
7		BFSE2420	POMPA ACQUA COMPLETA			150,23
8		BT3E1185	CORPO POMPA ACQUA			68,32
9		99009104	ANELLO ELASTICO RADIALE			3,38
10		95E3206025	VITE T.E. FLG M6x25 Zn.GIALLA			3,09
11		95E3206020	VITE T.E. FLG M6x20 Zn.GIALLA			3,09
12		9043006803	RONDELLA ALLUMINIO D.6x11x1			3,01
13		9131206020	VITE T.C.C.E. M6x20 Zn.BIANCA			3,09
14		93306000Y	CUSCINETTO D.10X26X8			21,30
15		93210398	ANELLO DI TENUTA X POMPA ACQUA			5,73
16		9321019X	ANELLO O-R 19X2,4			3,06
17		52S12439	ANELLO TENUTA OR X TERMOSTATO			4,92
18		B63E2223	PARAOLIO D.10X31X13,5			66,63

OIL PUMP









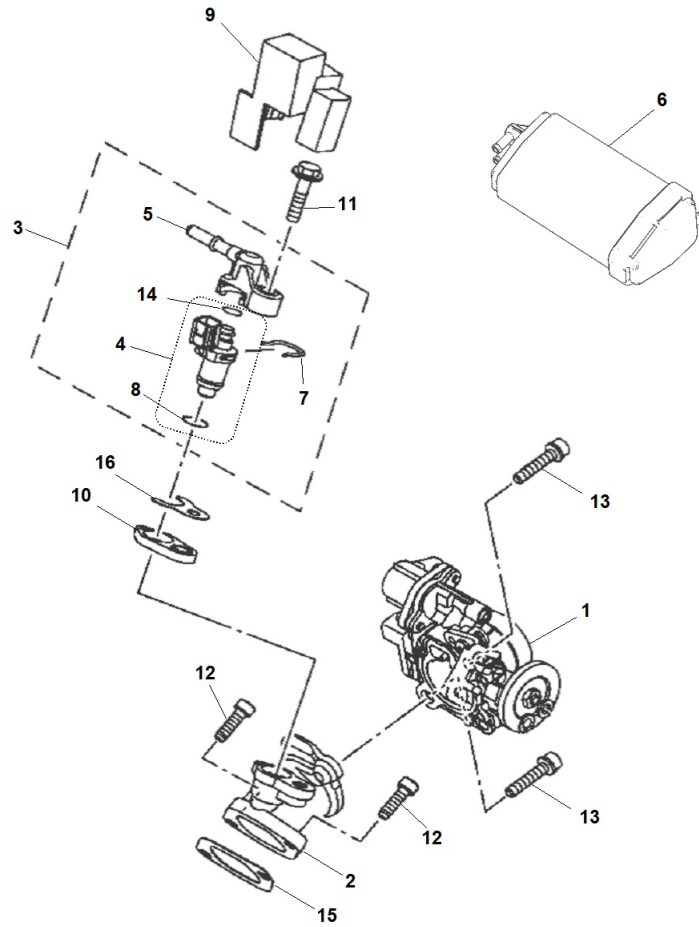









OIL PUMP

N.		Part n°	Description	Notes	Notes	Taxable price (€)
1		2PVE3300	POMPA OLIO COMPLETA			32,24
2		38BE3411	RETINA FILTRO OLIO			4,34
3		38BE3440	FILTRO OLIO COMPLETO			27,78
4		1S7E5351	COPERCHIO FILTRO OLIO			9,08
5		3C1E3327	COP.INGRANAGGIO POMPA OLIO			4,04
6		2PKE3447	COPERCHIO FILTRO OLIO NERO			33,96
7		2PVE3324	INGR. CONDUTTORE POMPA OLIO			19,99
8		4600052	MOLLA FILTRO			3,23
9		90105060	VITE T.E.FLG M6x12 C/FRENAFIL.			4,19
10		90111058	VITE T.B.E.I. M5x25			3,38
11		95E3206020	VITE T.E. FLG M6x20 Zn.GIALLA			3,09
12		95E3206080	VITE T.E. FLG M6x80 Zn.GIALLA			3,38
13		93210548	ANELLO DI TENUTA OR.D.53,6x2,4			3,72
14		5301782	OR			8,88

INTAKE







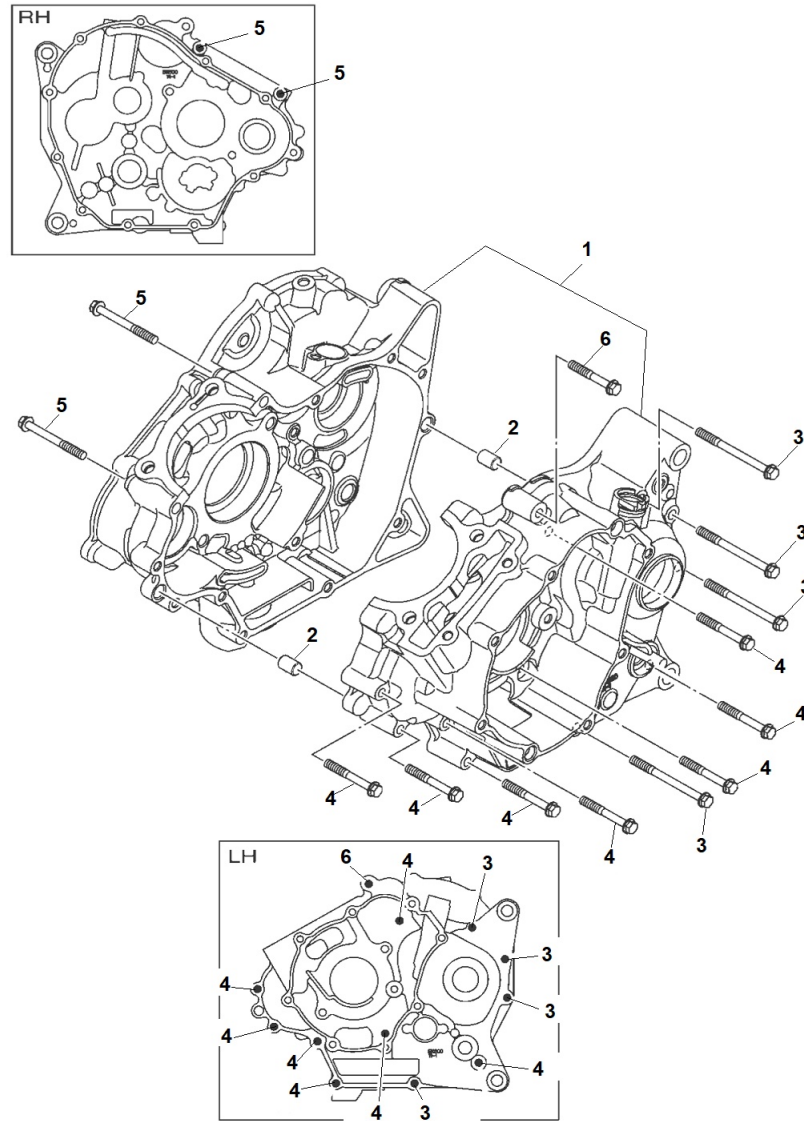

INTAKE

N.		Part n°	Description	Notes	Notes	Taxable price (€)
1		BK7E3750	CORPO FARFALLATO			270,63
2		BK6E3585	COLLETORE			22,31
3		BB8E3770	INIETTORE COMPLETO			90,70
4		BB8E3761	INIETTORE NUDO			127,08
5		54PE3938	COPERCHIO INIETTORE			21,43
6		2FBF4170	CANISTER			37,04
7		54PE4137	CLIP FERMA INIETTORE			13,27
8		5CAE4147	ANELLO DI TENUTA X INIETTORE			13,97
9		BK6E3767	CAPPUCCIO PROTEZIONE INIETTORE			5,04
10		2FBE3556	DISTANZIALE ISOLATORE INIETT.			4,26
11		9010506122	VITE T.E.FLG M6x30 C/FRENAFIL.			3,97
12		9131206020	VITE T.C.C.E. M6x20 Zn.BIANCA			3,09
13		90110068	VITE TCCE M6X30			3,38
14		54PE4147	ANELLO TENUTA OR PER INIETTORE			12,94
15		BK6E4199	GUARNIZIONE COLLETORE			3,31
16		BK6E3557	GUARNIZIONE ISOLATORE INIETT.			3,31

SUMP



SUMP

N.		Part n°	Description	Notes	Notes	Taxable price (€)
1		B5GE5150	COPPIA CARTER			842,79
2		5602672	GRANO DI RIF.D.10X14- INT.D.8,5			3,38
3		95E3206070	VITE T.E. FLG M6x70 Zn.GIALLA			3,38
4		95E3206045	VITE T.E. FLG M6x45 Zn.GIALLA			3,23
5		95E3206055	VITE T.E. FLG M6x55 Zn.GIALLA			3,23
6		95E3206040	VITE T.E. FLG M6x40 Zn.GIALLA			3,09

COVERS

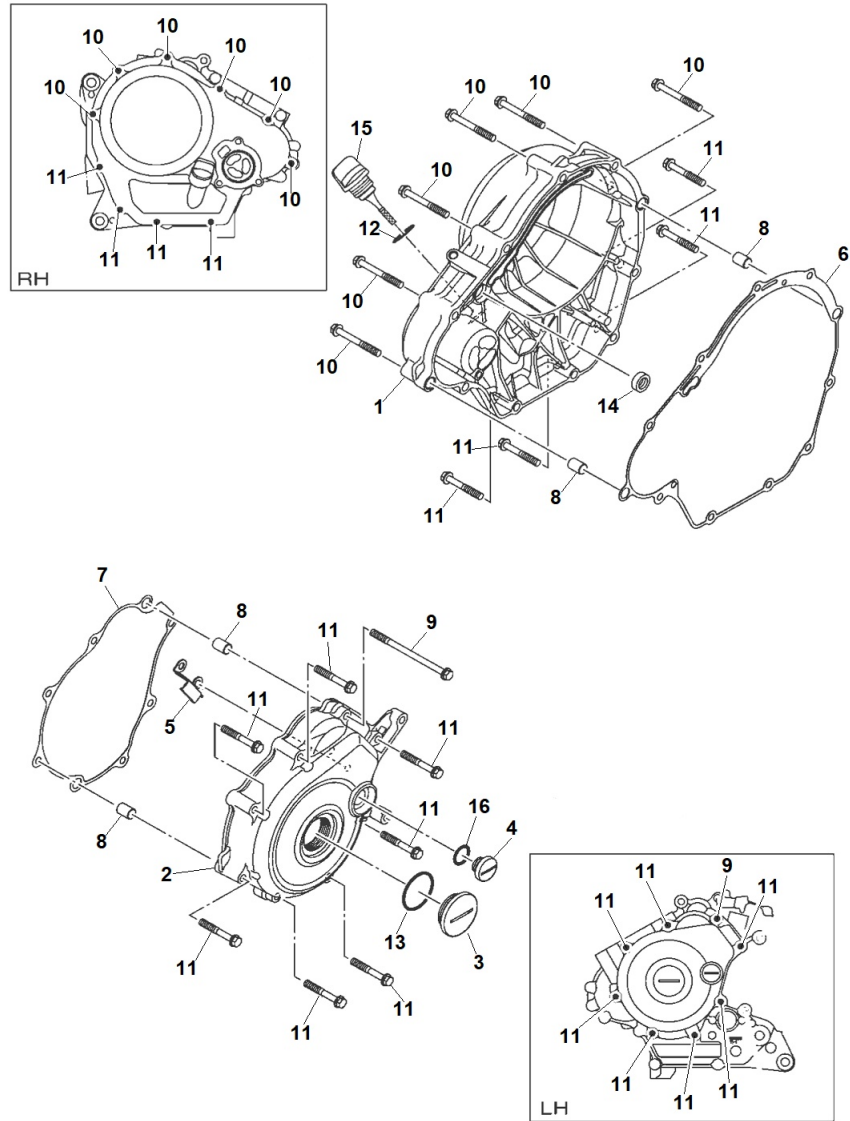

COVERS

N.		Part n°	Description	Notes	Notes	Taxable price (€)
1		BK6E5421	COPERCHIO FRIZIONE			121,02
2		BK6E5411	COPERCHIO VOLANO			82,07
3		90340328	TAPPO FILETTATO			5,66
4		90340148	TAPPO FILETTATO			9,11
5		2PVE5113	PIASTRINA			3,75
6		BK6E5461	GUARNIZIONE COPERCHIO FRIZIONE			27,34
7		BK6E5451	GUARNIZIONE COPERCHIO VOLANO			16,02
8		5602672	GRANO DI RIF.D.10X14- INT.D.8,5			3,38
9		95E3206090	VITE T.E. FLG M6x90 Zn.GIALLA			3,38
10		95E3206050	VITE T.E. FLG M6x50 Zn.GIALLA			3,23
11		95E3206040	VITE T.E. FLG M6x40 Zn.GIALLA			3,09
12		9321019X	ANELLO O-R 19X2,4			3,06
13		9321032813	ANELLO TENUTA OR D.31,5x2,4			4,04
14		931011014	PARAOILIO D.18X10X6			8,34
15		BK6E5362	TAPPO LIVELLO OLIO			5,44
16		93210148	ANELLO O.R. D.13,5x2,2 X TAPPO			3,50

IGNITION

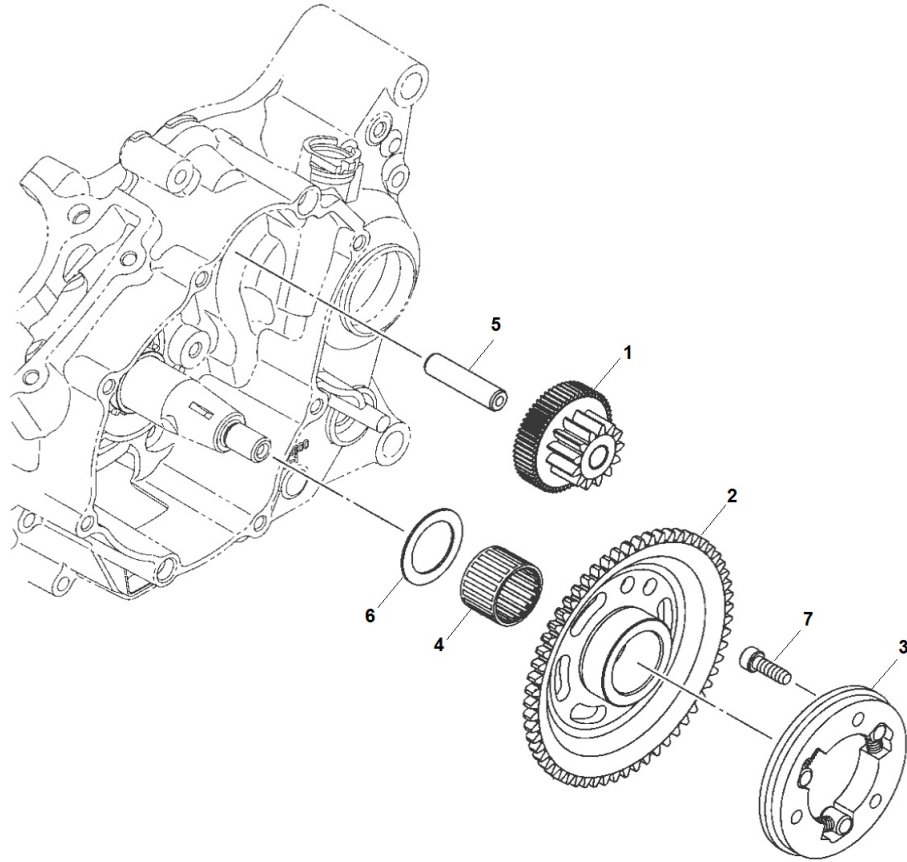







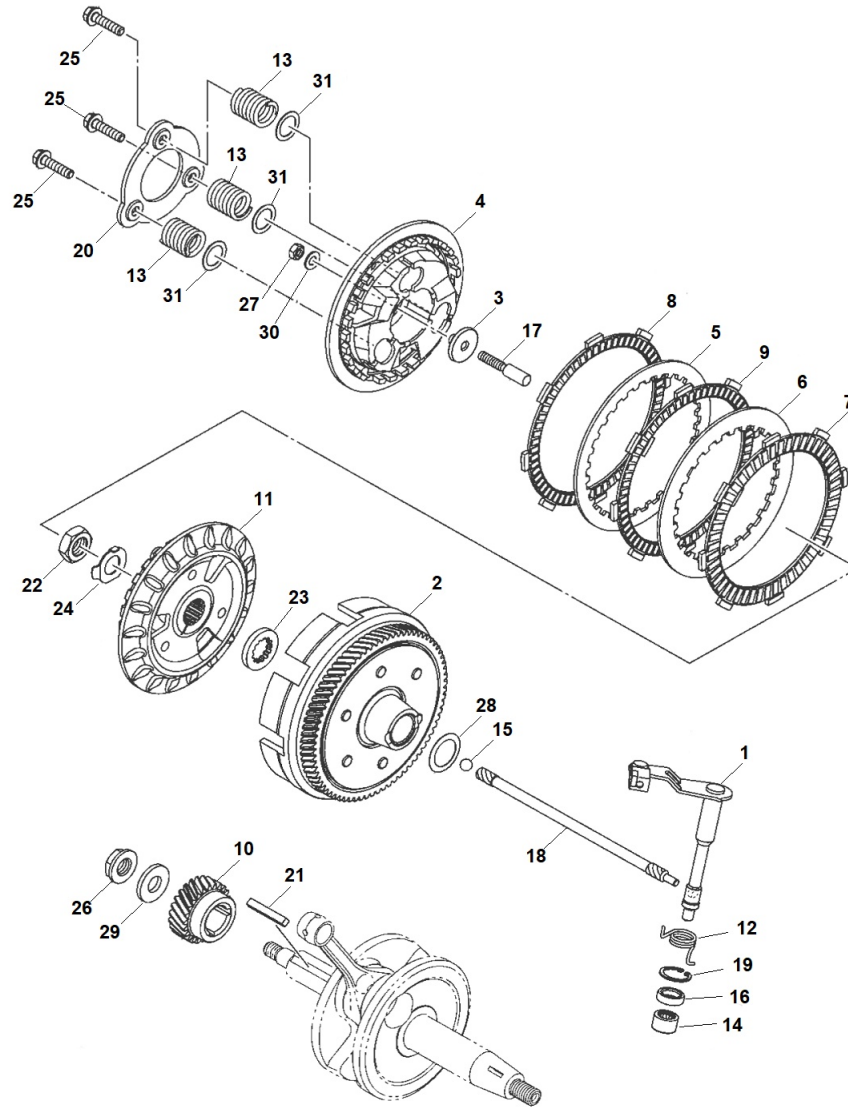













IGNITION

N.		Part n°	Description	Notes	Notes	Taxable price (€)
1		B48E5514	INGRANAGGIO DOPPIO INTERMEDIO			60,24
2		2PVE5524	INGR. AVVIAMENTO ELETTRICO			61,27
3		2PVE5580	RUOTA LIBERA COMPLETA			26,97
4		93310325X	GABBIA A RULLI D.25X30X19,8			11,14
5		BK7E5521	PERNO SUPPORTO INTERMEDIO			15,18
6		4907169	RONDELLA PIANA D.25,2X36X1			3,31
7		1PME5768	VITE TCCE M6x20 GIALLA C/FREN.			3,90

CLUTCH



CLUTCH

N.		Part n°	Description	Notes	Notes	Taxable price (€)
1		BK7E6380	LEVA DISINNESTO FRIZIONE			12,27
2		B5GE6150	CAMPANA FRIZIONE COMPLETA			209,33
3		3C1E6358	PIASTRA FRIZIONE			17,35
4		BK6E6351	SPINGIDISCO FRIZIONE			92,10
5		BK6E6324	DISCO FRIZIONE CONDOTTO 1			22,12
6		BK6E6325	DISCO FRIZIONE CONDOTTO 2			22,12
7		2NDE6321	DISCO FRIZIONE CONDUTTORE 1			26,02
8		BK6E6331	DISCO FRIZIONE CONDUTTORE 2			22,49
9		BK6E6321	DISCO FRIZIONE CONDUTTORE 3			14,48
10		938221480	PIGNONE Z.14			18,12
11		BK6E6371	TAMBURINO FRIZIONE			73,91
12		BK6E6345	MOLLA RITORNO ASTA FRIZIONE			3,97
13		BK6E6333	MOLLA FRIZIONE 1			6,32
14		93315112	GABBIA RULLI 12 X 16 X 10			6,62
15		93505168	SFERA			3,01
16		931021286	PARAOLIO 18 X 12 X 5			3,57
17		3C1E6356	PERNO TIRA FRIZIONE			30,72
18		38BE6357	ASTA SPINGIDISCO FRIZIONE			12,39
19		0303349	SEEGER			2,50
20		BK6E6352	PIASTRA MOLLE FRIZIONE			26,68

CLUTCH

N.		Part n°	Description	Notes	Notes	Taxable price (€)
21		3C116193	CHIAVETTA 5X5X33			8,38
22		90170148	DADO M14x1 H=8 CH=22			4,78
23		2NDE6154	RONDELLA SOTTO TAMBURINO FRIZ.			16,32
24		90215148	RONDELLA C/LINGUETTE D.26x14x1			3,72
25		BK6E6337	VITE PER MOLLA FRIZIONE			3,38
26		901791265	DADO M12X1 H=8			7,09
27		3C1E6344	DADO PER FRIZIONE			2,50
28		90208200	RONDELLA CONICA			3,28
29		90201120	RONDELLA PIANA D.12x27x3			3,97
30		54BE6144	RONDELLA PER FRIZIONE			3,50
31		BK6E6774	RONDELLA PER MOLLA FRIZIONE			3,97

GEARSHIFT

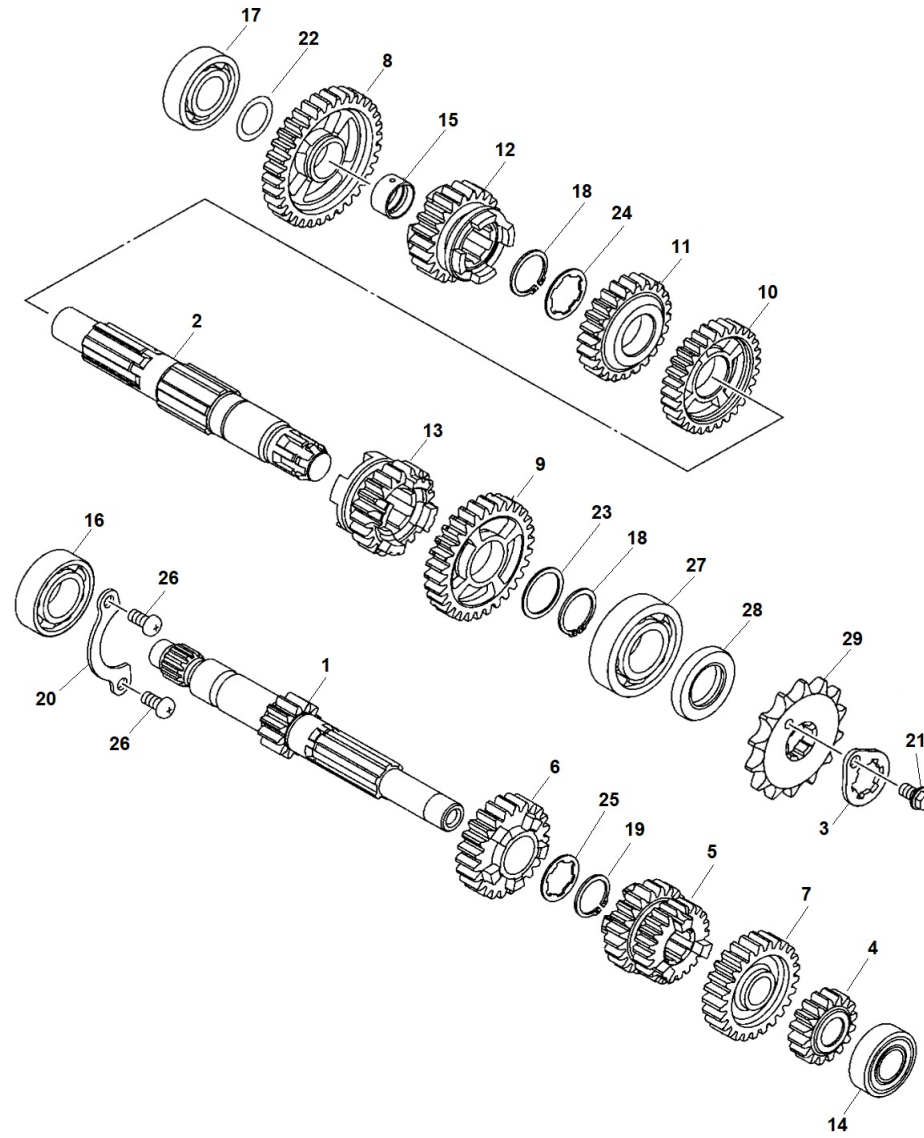

GEARSHIFT

N.		Part n°	Description	Notes	Notes	Taxable price (€)
1		BK6E7411	ALBERO PRIMARIO			99,86
2		BK6E7421	ALBERO SECONDARIO			76,48
3		1S7E7456	PIASTRINA RITEGNO PIGNONE			3,31
4		3C1E7121	INGRANAGGIO 2^ SU ALB.PRIMARIO	Z16		44,07
5		5D7E7131	INGRANAGGIO 3^V.SUL PRIMARIO	Z22 / Z21		58,40
6		BK6E7151	INGR. 5^ SU PRIMARIO			52,85
7		BK6E7161	INGR. 6^ SU PRIMARIO			50,35
8		3C1E7211	INGRANAGGIO 1^ SU ALB.SECOND.	Z34		51,86
9		BK6E7221	INGR.2 SU SECONDARIO			132,15
10		BK6E7231	INGR. 3^ SU SECONDARIO			51,67
11		BK6E7241	INGR. 4^ SU SECONDARIO			56,60
12		BK6E7251	INGR.5 VELOCITA SU SECONDARIO			61,93
13		5D7E7261	INGRANAGGIO 6^V.SUL SECONDARIO	Z25		37,67
14		93306252	CUSCINETTO A SFERE 35X15X11			12,64
15		903871780	BOCCOLA ALBERO SECONDARIO			14,41
16		93306004X	CUSCINETTO SFERE D.20X42X12			10,63
17		93306253Y	CUSCINETTO 40X17X12			10,63
18		9341022	ANELLO SEEGER PER ALBERO			8,04
19		93410200	ANELLO SEEGER 20MM			3,28
20		3C1E7471	PIASTRINA RITEGNO CUSCINETTO			3,97







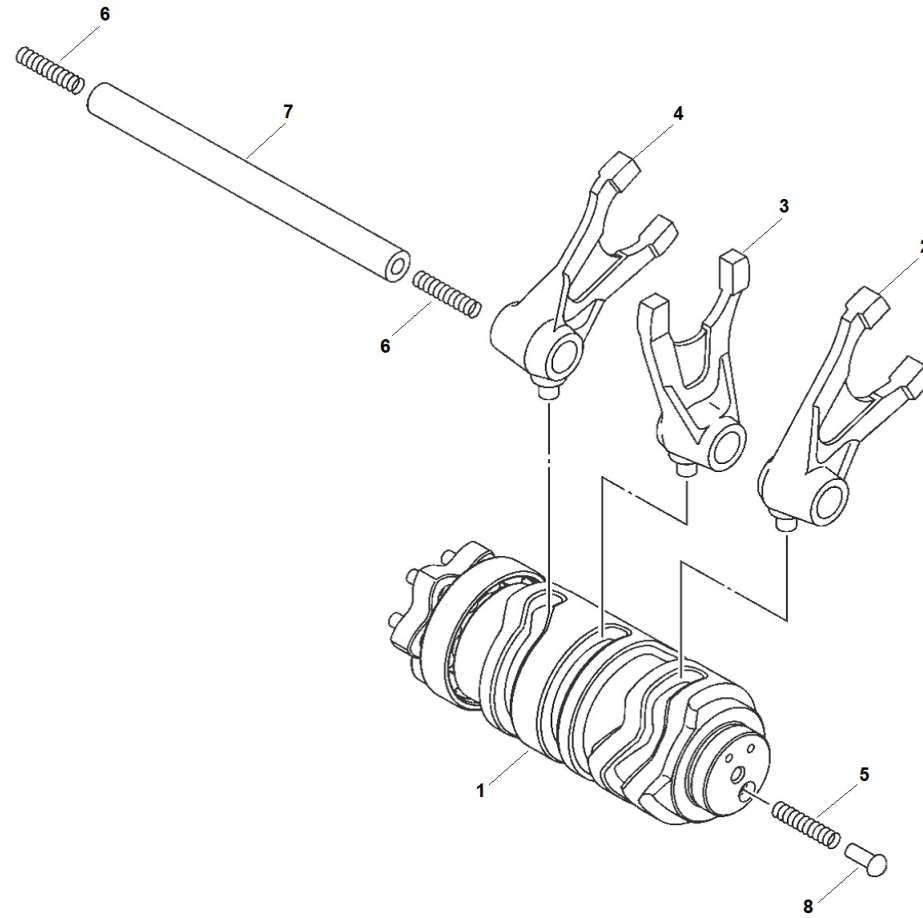

GEARSHIFT

N.		Part n°	Description	Notes	Notes	Taxable price (€)
21		95E32060	VITE T.E. FLG M6x10 Zn.GIALLA			3,01
22		95E3206040	VITE T.E. FLG M6x40 Zn.GIALLA			3,09
23		90201227	RONDELLA SU ALBERO SECONDARIO			6,80
24		9020918	RONDELLA PER ALBERO SECONDARIO			4,31
25		9020917	RONDELLA PER ALBERO PRIMARIO			10,13
26		9011006X	VITE TCCE 6 X 12			3,01
27		93306272Y	CUSCINETTO SFERE D. 22x50x14			31,61
28		9310222827	PARAOILIO D.38x21x6			5,04
29		938221480	PIGNONE Z.14			18,12

DESMO









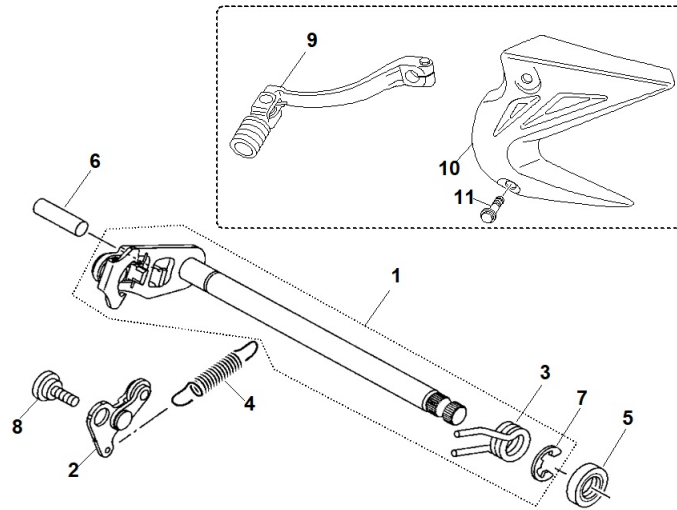





DESMO

N.		Part n°	Description	Notes	Notes	Taxable price (€)
1		BK6E8540	DESMODROMICO COMPLETO			101,47
2		3300060	FORCHETTA 1°-3° MARCIA			25,28
3		3300070	FORCHETTA 2°-4° MARCIA			25,28
4		3300080	FORCHETTA 5°-6° MARCIA			25,28
5		4604512	MOLLA FILO D.0,6			3,09
6		4601816	MOLLA PERNO GUIDA FORCHETTA			3,01
7		1PAE8531	PERNO GUIDA FORCHETTA			8,23
8		5TPE8542	SEGNAMARCE DESMO			3,57

SELECTOR



SELECTOR

N.		Part n°	Description	Notes	Notes	Taxable price (€)
1		2NDE8101	ALBERO SELETTORE COMPLETO			63,33
2		BK6E8140	PIASTRINA FERMA SELETTORE			9,19
3		905083283	MOLLA CAMBIO			5,88
4		BK6E8337	MOLLA SELETTORE MARCE			3,82
5		93102128	PARAOLIO 12X22X5			3,61
6		93608308	SPINA DI RIFER.PER SELETTORE			9,33
7		99002106	SEEGER PER SELETTORE			3,82
8		90109062	VITE FISSAGGIO PIASTRINA			3,75
9		KW0008350	PEDALE CAMBIO GOMMINO 1254T RR			26,40
10		KW2311515	PARAPIGNONE HM 125 4T			6,39
11		TEF06X010	VITE TEF 6X10 FLANGIATA ZNB			1,39

GENERATOR

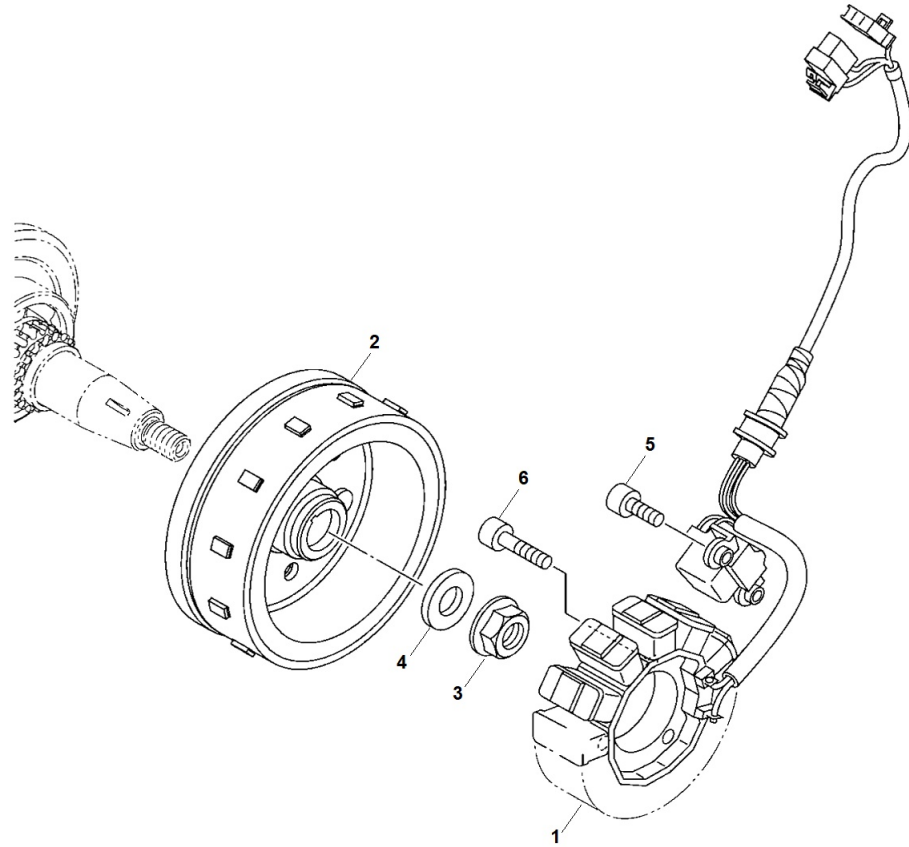





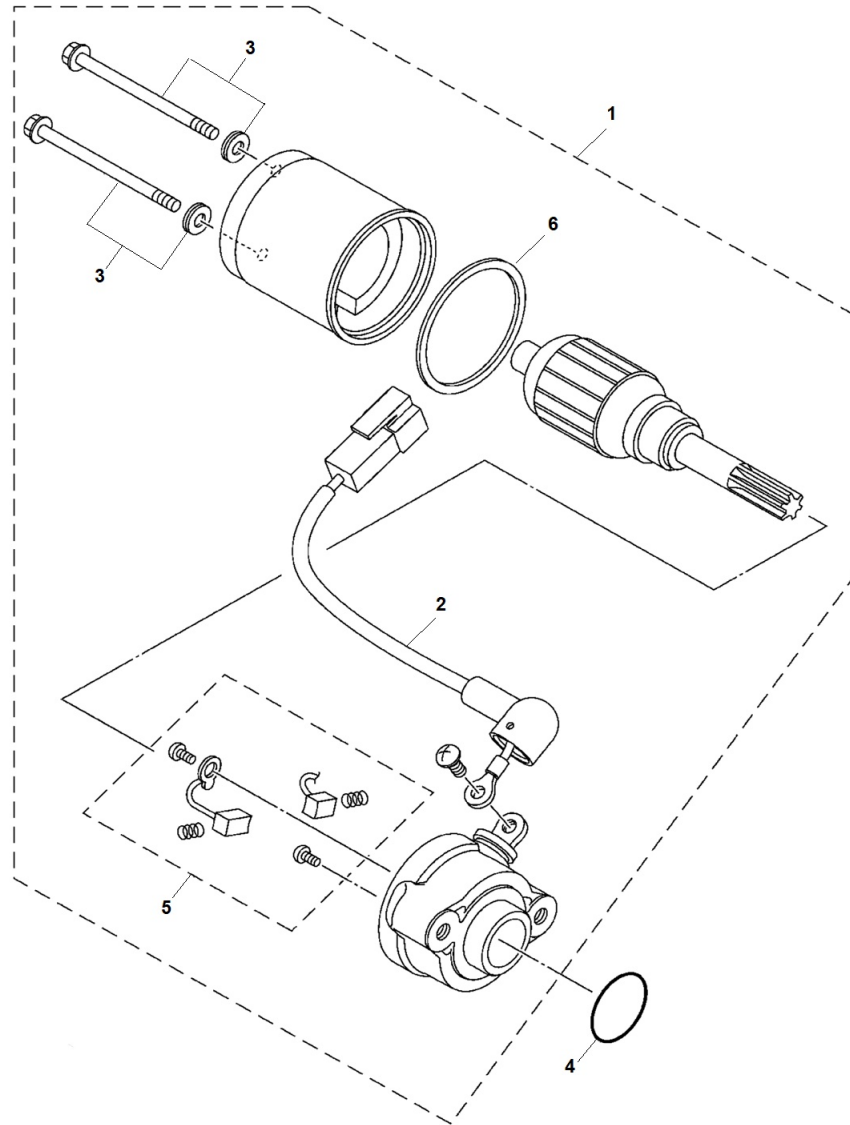

GENERATOR

N.		Part n°	Description	Notes	Notes	Taxable price (€)
2		2PVH1450	ROTORE VOLANO			155,02
3		957071250	DADO FLG M12X1,25X11			4,95
4		90201120	RONDELLA PIANA D.12x27x3			3,97
5		90110X96	VITE TCCE M6 X 16			3,28
6		90110067	VITE TCCE M6X25			3,01

STARTER MOTOR









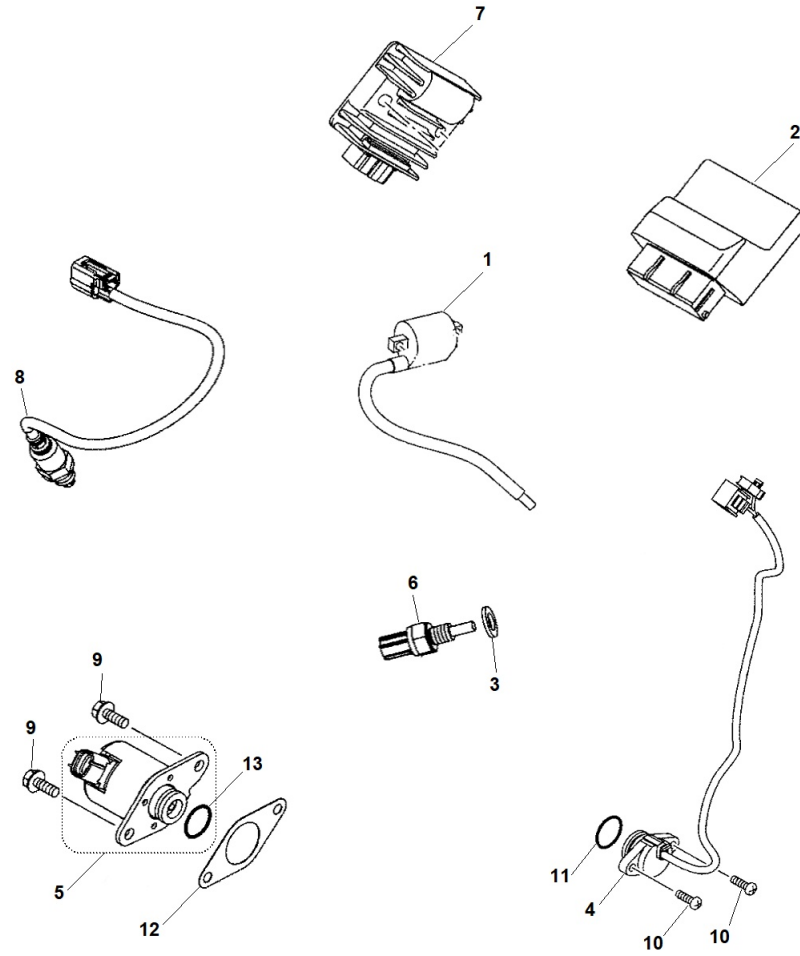





STARTER MOTOR

N.		Part n°	Description	Notes	Notes	Taxable price (€)
1		BK6H1800	MOTORINO AVVIAMENTO			141,75
2		1FDH183G	CABLAGGIO X MOTORINO AVVIAM.			7,94
3		5D9H1828	VITE PER MOTORINO AVVIAMENTO			17,05
4		93210268	ANELLO DI TENUTA OR D.25,5x2,4			3,50
5		2PHH1801	SET SPAZZOLE X MOTORINO AVV.			17,79
6		5D9H1861	GUARNIZIONE PER MOTORINO AVV.			14,85

ELECTRICAL COMPONENTS









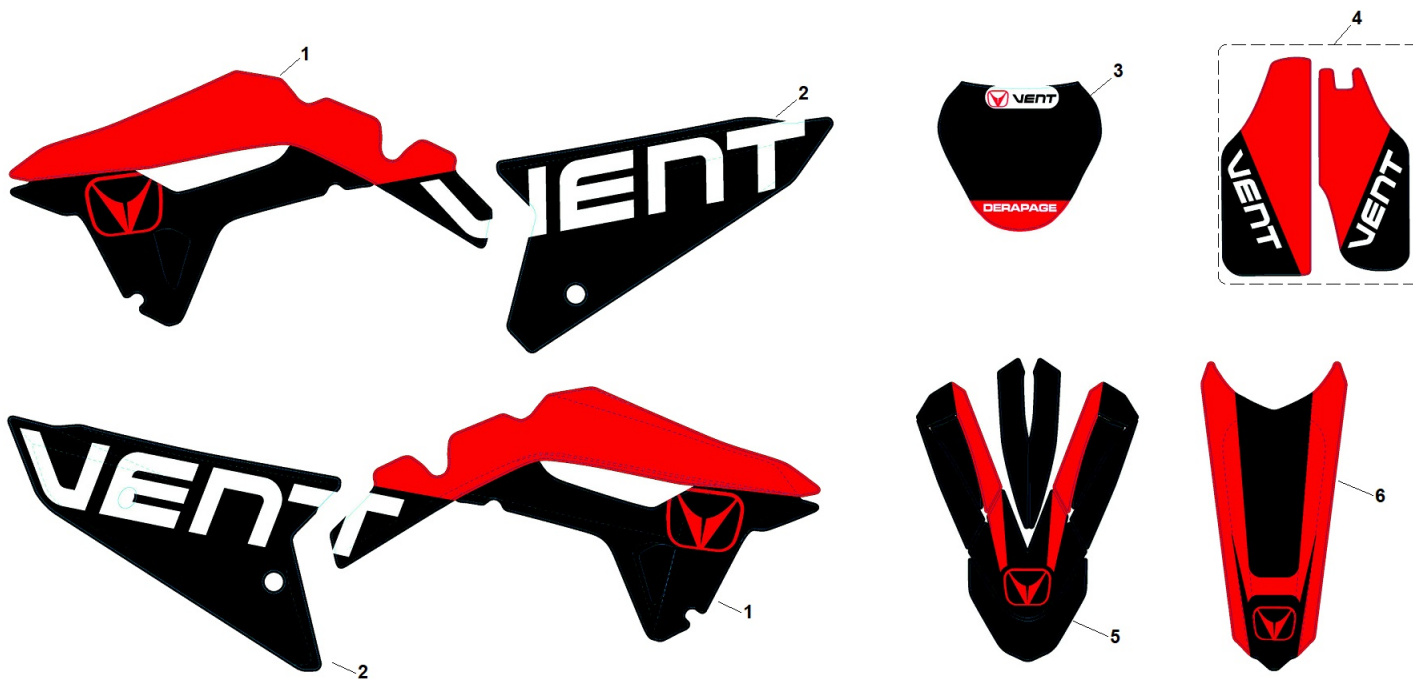





ELECTRICAL COMPONENTS

N.		Part n°	Description	Notes	Notes	Taxable price (€)
1		2UPH2310	BOBINA			38,12
3		90430108	RONDELLA RAME D.10,2x18x2			4,92
4		BK6H2540	INTERRUTTORE SPIA FOLLE			37,04
5		BK6H6110	VARIATORE FASE VALVOLE			139,72
6		52BH3591	SONDA TEMPERATURA ACQUA			32,01
7		BK6H1960	REGOLATORE DI TENSIONE			84,01
8		B0TH592A	SONDA LAMBDA			125,46
9		95D3206016	VITE T.E. FLG.M6x16 Zn.GIALLA			3,09
10		9014905X	VITE TCB M5x16 GIALLA S/LOCTIT			3,31
11		93210218	ANELLO DI TENUTA OR D.20,8x2,4			3,09
12		BK6H1861	GUARNIZ.VARIATORE FASE VALVOLE			3,31

ADHESIVES





ADHESIVES

N.		Part n°	Description	Notes	Notes	Taxable price (€)
1		KW1521604	CP.ADESIVI CONVOGLIATORI NERO		Nero	38,33
1		KW1521608	CP.ADESIVI CONVOGLIATORI BIANC		Bianco	38,33
2		KW1521704	CP.ADESIVI PORTANUMERO NERO		Nero	21,53
2		KW1521708	CP.ADESIVI PORTANUMERO BIANCO		Bianco	21,53
3		KW1521504	ADESIVO MASCHERINA NERO		Nero	14,18
3		KW1521508	ADESIVO MASCHERINA BIANCO		Bianco	14,18
4		KW1521204	CP. ADESIVI PARASTELI NERO		Nero	10,45
4		KW1521208	CP. ADESIVI PARASTELI BIANCO		Bianco	10,45
5		KW1521304	ADESIVO PARAFANGO ANT. NERO		Nero	16,38
5		KW1521308	ADESIVO PARAFANGO ANT. BIANCO		Bianco	16,38
6		KW1521904	ADESIVO PARAFANGO POST. NERO		Nero	14,18
6		KW1521908	ADESIVO PARAFANGO POST. BIANCO		Bianco	14,18

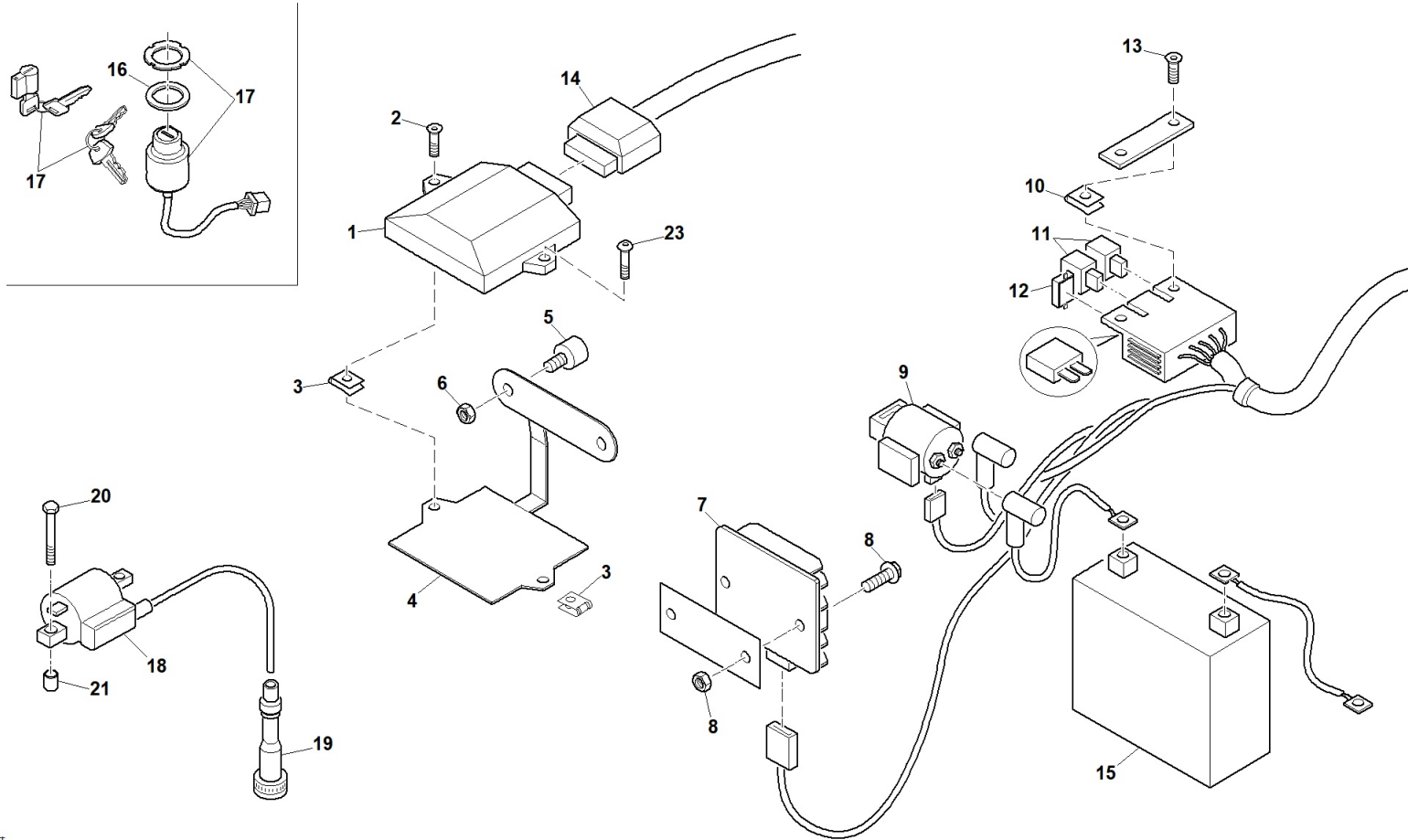
ELECTRICAL SYSTEM



ELECTRICAL SYSTEM

N.		Part n°	Description	Notes	Notes	Taxable price (€)
1		0705441	CENTRALINA WR125 EU-5 VENT			325,31
2		W00369	VITE TBEI 5X12 ISO 7380 C.10.9			2,78
3		KMM12045	CLIPS M5 LUNGA			4,17
4		KW2421550	SUPPORTO CENTRALINA 125-4T EU5			9,14
6		K01019053	DADO M6 FLANG.ZIGRINATO ZNB			0,11
7		BK6H1960	REGOLATORE DI TENSIONE			84,01
9		K02806060	RELE' AVVIAMENTO 15 AMP. 12V			21,25
13		W28440	VITE TBEI 4X10 7380 10.9 ZNB			2,78
15		KW2808525	BATTERIA 125			77,01
17		K03510020	KIT SERRATURE + ACCESSORI			67,38
18		2UPH2310	BOBINA			38,12
19		KW2808105	CAPPUCCIO CANDELA HM F125			10,14
20		W00194	VITE TCE 6X40			2,78
21		KW3421130	BUSSOLA APPOGGIO BOBINA H13			0,37
23		W20335	VITE TBEI 5X16 ISO 7380 C.10.9			2,87

INTAKE

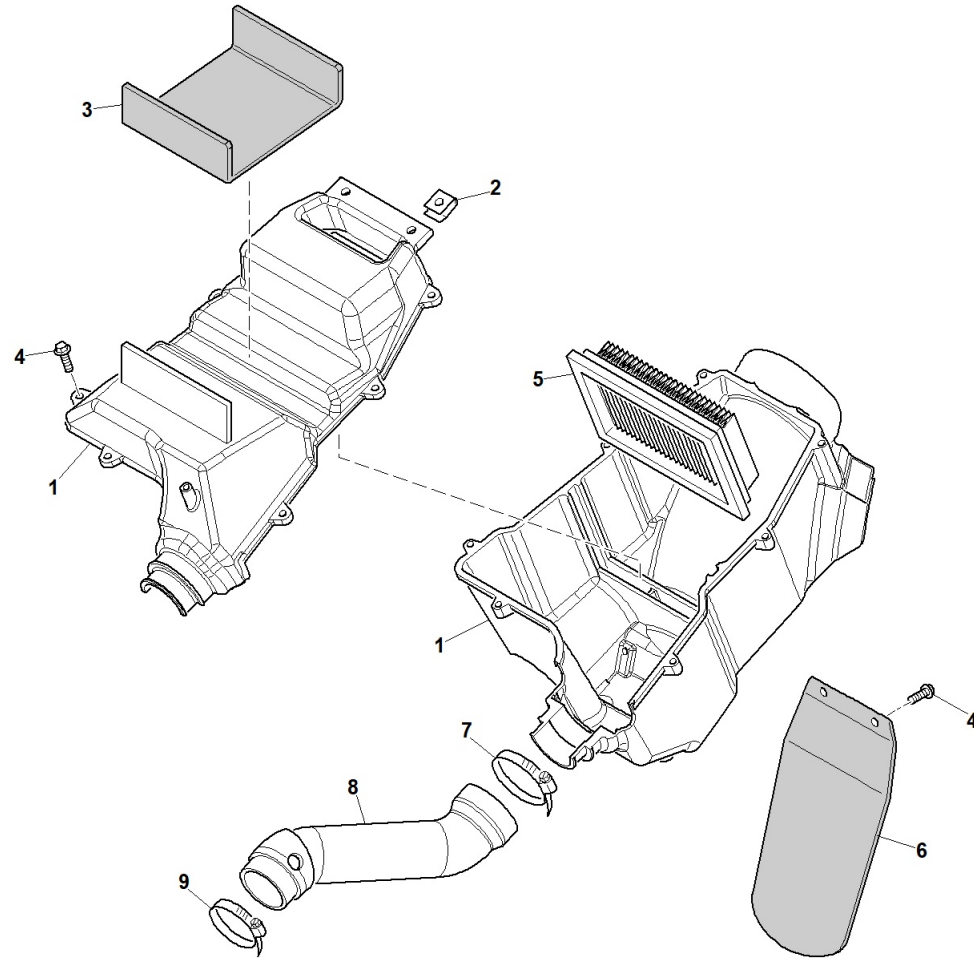



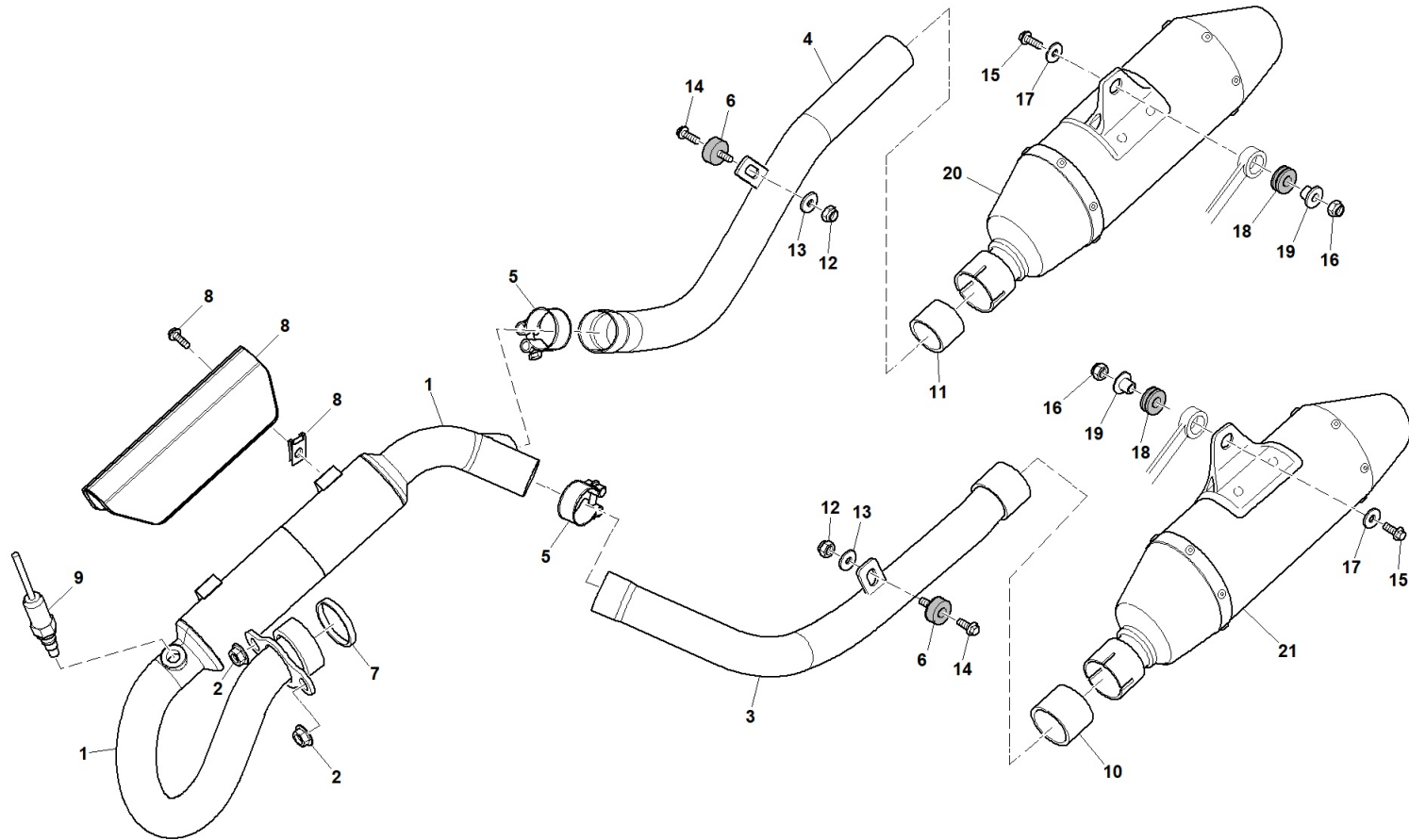

INTAKE

N.		Part n°	Description	Notes	Notes	Taxable price (€)
1		KW2321735	CASSA FILTRO ARIA 125-4T EU5			61,95
2		W00441	CLIPS M6			1,39
4		W00433	VITE TE 4,8X16 AUTOF.6950 F/R.			2,78
5		KW2321775	FILTRO ARIA 149X95X32			18,90

EXHAUST









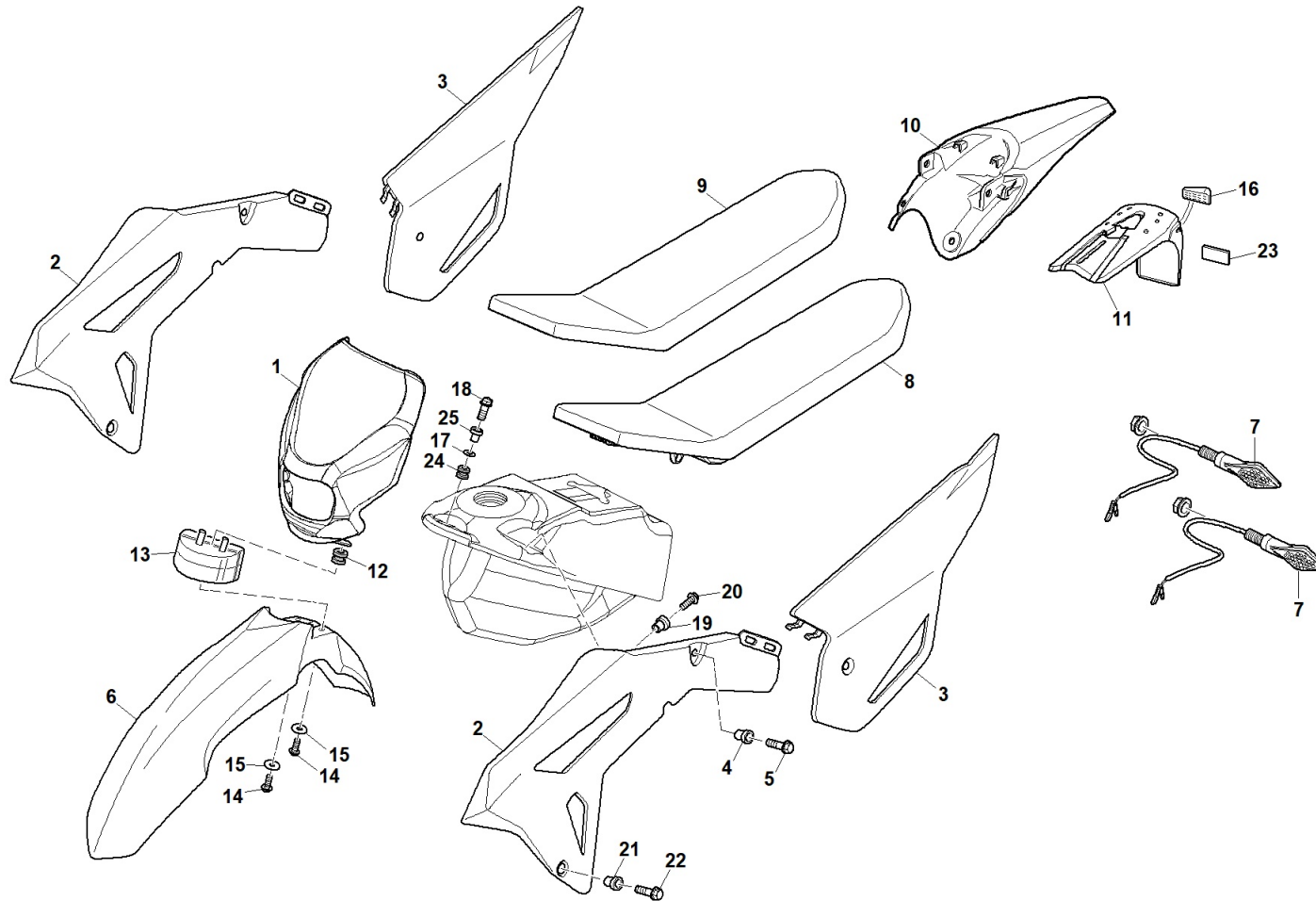













EXHAUST

N.		Part n°	Description	Notes	Notes	Taxable price (€)
2		W20331	DADO M8 FLANGIATO ZIGRIN.BASSO			2,78
3		KW3621080	RACCORDO SX 125-4T EU5			75,00
4		KW3621090	RACCORDO DX 125-4T EU5			69,00
5		KW3619247	COLLARE A BULLONE W2 32-35 H21			10,28
6		K01001020	SILENTBLOCK SILICONE MARMITTA			5,36
7		BK7E4613	GUARNIZIONE TUBO SCARICO			6,62
8		KW3621050	PARACALORE 125-4T EU5			39,00
9		B0TH592A	SONDA LAMBDA			125,46
10		KW3620337	GUARNIZIONE SX SILENZ END MY20			10,42
11		KW3620336	GUARNIZIONE DX SILENZ END MY20			9,26
12		KMM00006	DADO M6 GALLY			2,78
13		W00412	RONDELLA 6,5X18X1,5 DIN 9021			1,39
14		TEF06X010	VITE TEF 6X10 FLANGIATA ZNB			1,39
15		TEF06X016	VITE TEF 6X16 FLANGIATA ZNB			1,39
16		KW1208026	DADO AUTOBL.BASSO INS.INOX M8			4,24
17		K01020824	RONDELLA 8X24 ZNB			0,16
18		W22164	GOMMINO SILENZIATORE EPDM NERO			4,17
19		K03703210	BUSSOLA SILENZIATORE FORO D.7			2,78

BODYWORK



BODYWORK

N.		Part n°	Description	Notes	Notes	Taxable price (€)
1		KW2321504	MASCHERINA PLASTICA MY21 NERO		NERO	19,95
1		KW2321508	MASCHERINA PLASTICA MY21 BIANC		BIANCO	19,95
2		KW2321604	CP CONVOGLIATORE 125-4T EU5 NE		NERO	36,65
2		KW2321608	CP CONVOGLIATORE 125-4T EU5 BI		BIANCO	36,65
3		KW2321704	CP PORTA-NR LAT 125-4T E5 NERO		NERO	41,79
3		KW2321708	CP PORTA-NR LAT 125-4T E5 BIAN		BIANCO	41,79
4		KW3721601	BUSSOLA CONVOGL D.16 H.4.3			1,14
6		K02321144	PARAFANGO ANT MOT MY21 NERO		NERO	34,07
6		K02321148	PARAFANGO ANT MOT MY21 BIANCO		BIANCO	34,07
7		K02820431	FRECCIA POSTERIORE MY20			14,89
8		KW2521200	SELLA ROSSO/NERO 125-4T EU5			89,25
10		KW2321904	PARAFAN POST 125-4T EU5 NERO		NERO	30,77
10		KW2321908	PARAFAN POST 125-4T EU5 BIANCO		BIANCO	30,77
11		K02310090C	PORTATARG CON FARO LED + SPINA			65,91
12		K02315821	GOMMINO PORTAFARO			0,69
14		TEF06X016	VITE TEF 6X16 FLANGIATA ZNB			1,39
15		W00412	RONDELLA 6,5X18X1,5 DIN 9021			1,39
16		K02310091C	GRUPPO OTTICO A LED SPINATO			42,32
17		W00954	RONDELLA 6,5X24X2 ZNB DIN 9021			1,39
20		W00369	VITE TBEI 5X12 ISO 7380 C.10.9			2,78

BODYWORK

N.		Part n°	Description	Notes	Notes	Taxable price (€)
21		KW3721602	BUSSOLA CONVOGL D.14 H.4.7			1,14
22		W20335	VITE TBEI 5X16 ISO 7380 C.10.9			2,87
23		K02207110	CATADIOTTRO POSTERIORE ROSSO			5,55

TANK

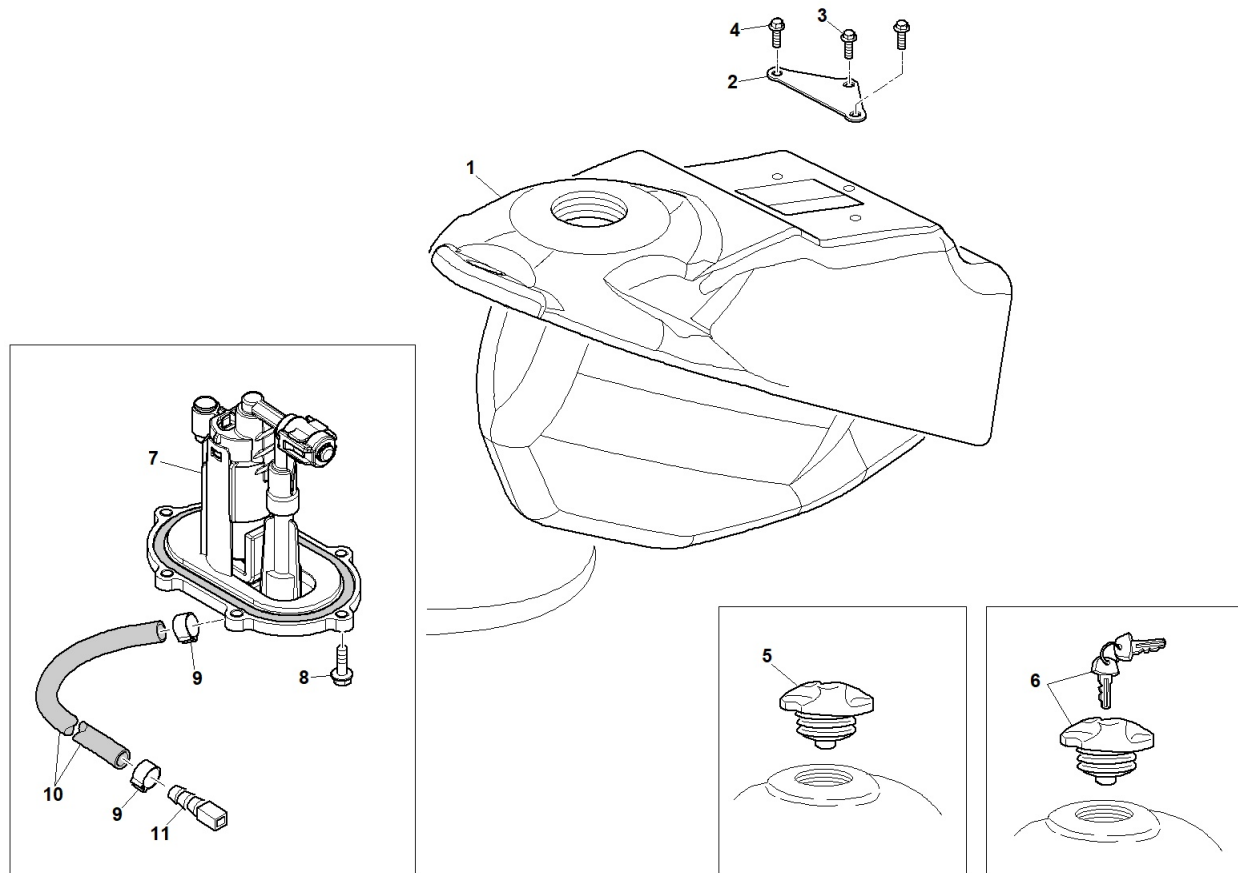





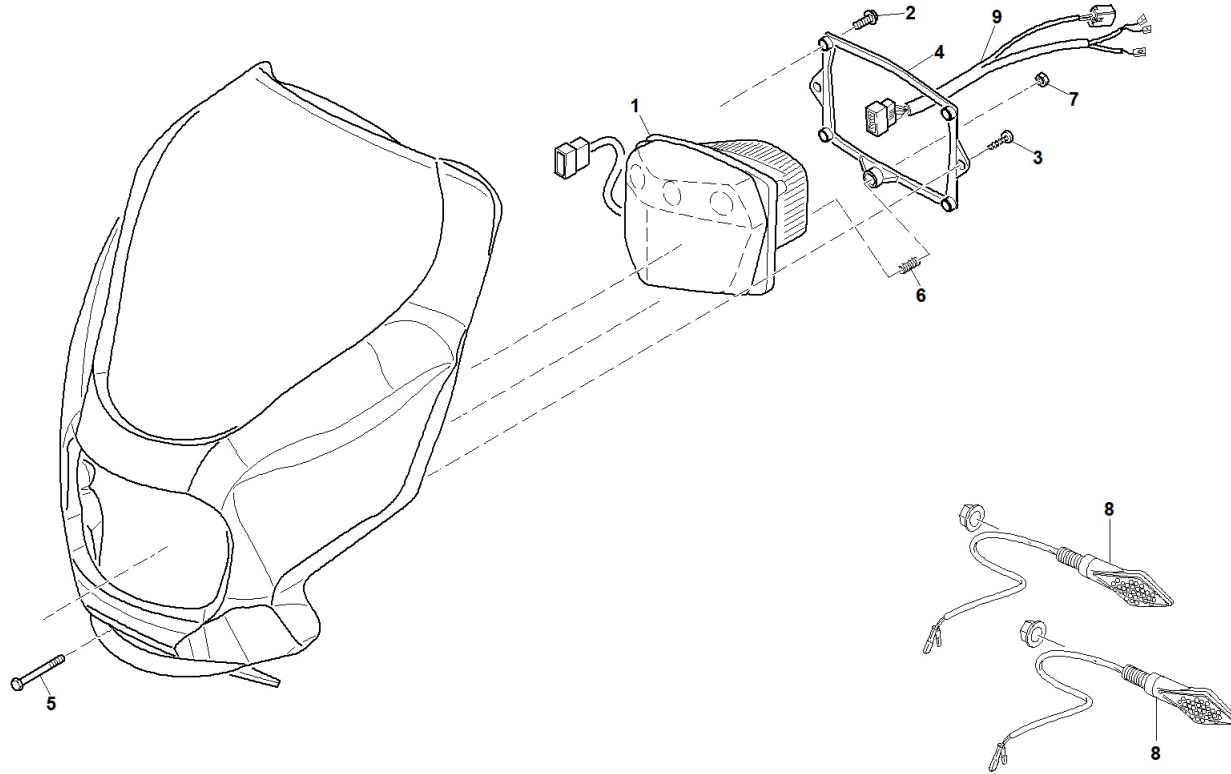

TANK

N.		Part n°	Description	Notes	Notes	Taxable price (€)
3		K01303146	VITE FISSAGGIO PARASTELO ZNB			2,64
4		W00433	VITE TE 4,8X16 AUTOF.6950 F/R.			2,78
5		K02321187	TAPPO SERBATOIO SFIATO MY21			13,79
9		KW1021145	FASCETTA OATIKER 14,5 125-4T			2,50
10		KW1021305	TUBO BENZINA L.370 HP PUR 14			5,60

HEADLIGHT













HEADLIGHT

N.		Part n°	Description	Notes	Notes	Taxable price (€)
1		K02310822	FARO ANTERIORE MASCHERINE CRM	MOTARD		50,59
2		W00433	VITE TE 4,8X16 AUTOF.6950 F/R.			2,78
6		KW1021001	MOLLA REG FASCIO ANT 125 EU5			0,60
7		W00151	DADO M4 AUTOBL. BASSO UNI 7474			2,78
8		K02820411	FRECCIA ANTERIORE MY20			14,55
9		K02810305	INTERFACCIA FARO CRM HM50	MOTARD		12,13

FORK

N.		Part n°	Description	Notes	Notes	Taxable price (€)
1		K03712241	FORCELLA PIE.STD-P.I.STD-MAN22			859,95
2		KLF41GR001	GR.PIASTRA INF.+CANNOTTO			229,22
3		KLF00141IAPSM	PIASTRA SUPER.FORCELLA USD HM			156,63
4		KLFPSF001Z	GHIERA CANNOTTO M25X100			24,54
5		KLFPSF002Z	DADO CANNOTTO HEX M25X100			16,83
6		KLFBM001M22M	CAVALLOTTO MANUBRIO HM D22			19,92
7		KA1243700	RONDELLA PARAPOLVERE FORCELLA			4,17
8		KW1008280	OR PARAPOLVERE 42X2,6 VITON 70			2,84
9		K03700200	CUSCINETTO STERZO 32005			11,81
10		KLF41CEB002C	STELO CROMATO ASSIEME MOLLE			244,49
11		KLF41GR002	TAPPO+ O-RING NBR70 40X3,5			63,90
12		KLF41GR006	GRUPPO FODERI			335,72
13		KLF41CEB001C	STELO CROMATO ASS. IDRAULICO			229,22
14		KLF41GR003	GRUPPO CARTUCCIA IDRAULICA			364,60
15		K01303146	VITE FISSAGGIO PARASTELO ZNB			2,64
15		KW1008280	OR PARAPOLVERE 42X2,6 VITON 70			2,84
16		KLF41PO001	PARAOLIO NOK 41X53X10X11,5			16,67
17		KLFPSV004	RONDELLA ALLUMINIO D52,8X43X2			19,45
18		KLFPSS002	ANELLO SEEGER PARAOLIO D.1,8			11,47
19		KLF41RP001	RASCHIAPOLV.NOK 40,9X53,4X6X14			16,67

FORK

N.		Part n°	Description	Notes	Notes	Taxable price (€)
20		K02306375	COPPIA PARASTELI BIANCHI		BIANCO	23,61
20		SM00120	COPPIA PARASTELI NERI		NERO	25,00
21		K01303145	COPPIA PIASTR FISS TUBO FR.ANT			3,48
22		KLF41GR005	GR.PIEDE DX+ O-RING NBR70 38X3			163,68
23		KLF41MC001	MOLLA COMPRESSIONE L.585			60,64
24		KLF41GR007	GRUPPO ASSE ASSIEME MOLLE			63,90
25		KLF41GR004	GR.PIEDE SX+ O-RING NBR70 38X3			160,91
26		KLFPSG001	TAPPO GOMMA PROTEZ.CANNOTTO			12,87
27		K01312395	SUPP.PASSACAVO TUBO FREN ANT			4,08
28		W23204	PASSACAVO TUBO FRENO-FARO ANT			2,78



FIRST SERIES SWINGARM

Verificare il proprio telaio nell'allegato "Scheda prodotto" premendo l'icona  in alto a destra.

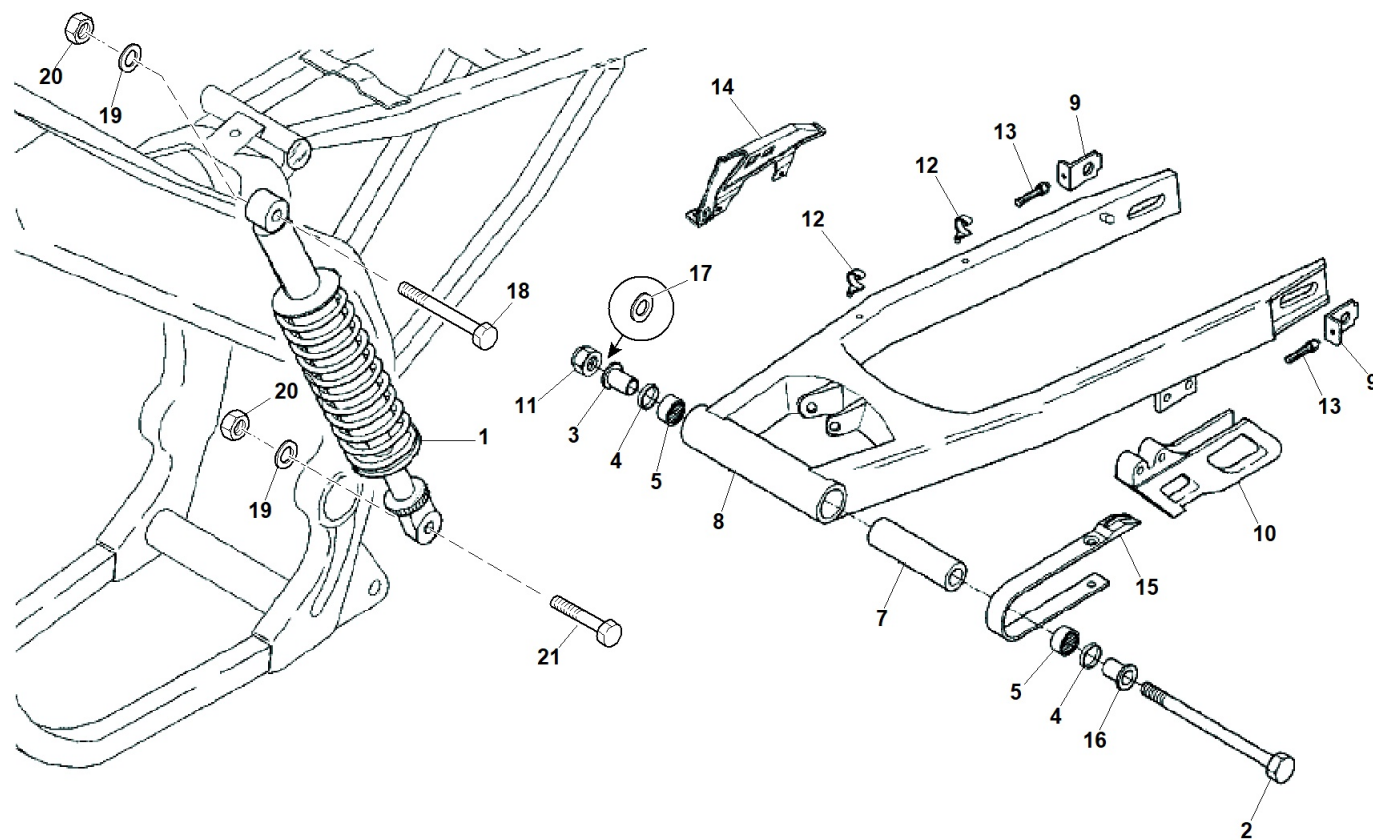
Se il telaio della vostra moto NON è fra quelli indicati nel file in allegato, consultare la tavola "Forcellone"









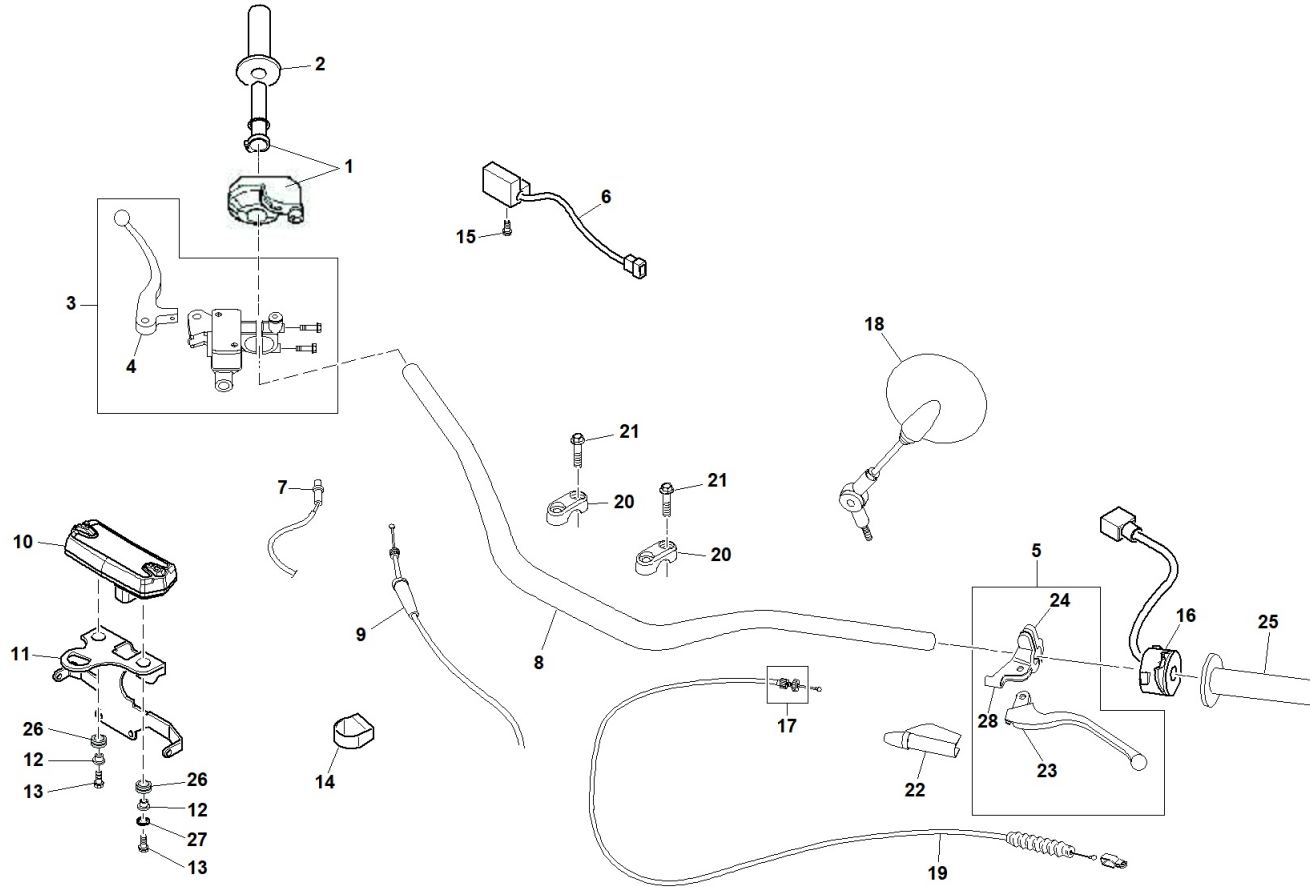









FIRST SERIES SWINGARM

N.		Part n°	Description	Notes	Notes	Taxable price (€)
1		K02710740	MONOAMMORTIZZATORE STD			154,35
2		KA3994500	PERNO FORCELLONE 222MM			16,67
3		K03794215N	BUSSOLA FORCELLONE ZN NERA			8,62
4		K03794220	PARAPOLVERE GABBIA R. G22X28X4			2,78
5		K03794150	GABBIA RULLI FORCELL FE HK2220			6,95
7		KA3495135	DISTANZIALE FORCELLONE			7,50
9		K03400070	PIASTRINA TENDICATENA			2,78
10		K01094475	CRUNA CATENA			15,42
11		KW3408056	DADO AUTOBL.M14X1,5 7474 ZNB			4,32
12		K01303310	GRAFFETTA FISSAGG.TUBO FR.POST			2,08
13		W00354	VITE TE 8X70 UNI 5739 CL. 8.8			2,78
14		K02311580	CARTER CATENA 50-125 4T			13,57
15		KT2310195	PATTINO STRISCIACATENA RIALZAT			12,51
16		K03794215N	BUSSOLA FORCELLONE ZN NERA			8,62
17		K03410360	RONDELLA FE D.14X26X2.0 ZNB			1,39
18		TEF10X043	VITE TEF 10X43 FLANGIATA			1,39
19		W00340	RONDELLA 10,5X21X2 UNI 6592			1,39
20		KW3708716	DADO AUTOBL.M10X1,25 7473 ZNB			4,32
21		TEF10X055	VITE TEF 10X55 FLANGIATA ZNB			4,02







HANDLEBARS



HANDLEBARS

N.		Part n°	Description	Notes	Notes	Taxable price (€)
1		K01094300	COMANDO GAS			14,99
2		K02094200	MANOPOLA DX NERA			5,68
3		K01318151	POMPA FRENO ANTERIORE	DA TELAIO ZEN50SE40EJ800106 BAJA - ZEN50SE40MJ800218 DERAPAGE		98,91
4		K01313177	KIT LEVA FRENO ANTERIORE	DA TELAIO ZEN50SE40EJ800106 BAJA - ZEN50SE40MJ800218 DERAPAGE		28,94
5		KW2021700	COMANDO LEVA C/STARTER+SUPP.SP			46,90
6		K02803090	PULSANTE START			12,24
7		W00116	INTERRUTTORE STOP			6,95
8		K02018455A	MANUBRIO ACCIAIO V/ARG.			26,15
9		KW2221600	CAVO GAS 125-4T EU5			17,50
10		KW5221255	STRUM CONTAKM EVEREST 125-EU5			93,71
12		KW5221180	BUSSOLA DIST CONTA-KM EVEREST			1,79
13		W24443	VITE TBEI 4 X 20 ZNB			2,78
14		W23204	PASSACAVO TUBO FRENO-FARO ANT			2,78
16		K02810200C	GR.COMMUTATORE S/PULS.MASSA			53,26
17		395502015HM	REGISTRO FRIZIONE DI			0,00
18		KW2121520	CP SPECCHIETTI M10X1.25 FA-415			46,31
19		KW2221610	CAVO FRIZIONE 125-4T EU5			17,90
20		KLFBM001M22M	CAVALLOTTO MANUBRIO HM D22			19,92
21		KLFPSC004	VITE DIN 912 M8X25			8,61
22		K02004900	COPRILEVA SX			4,17







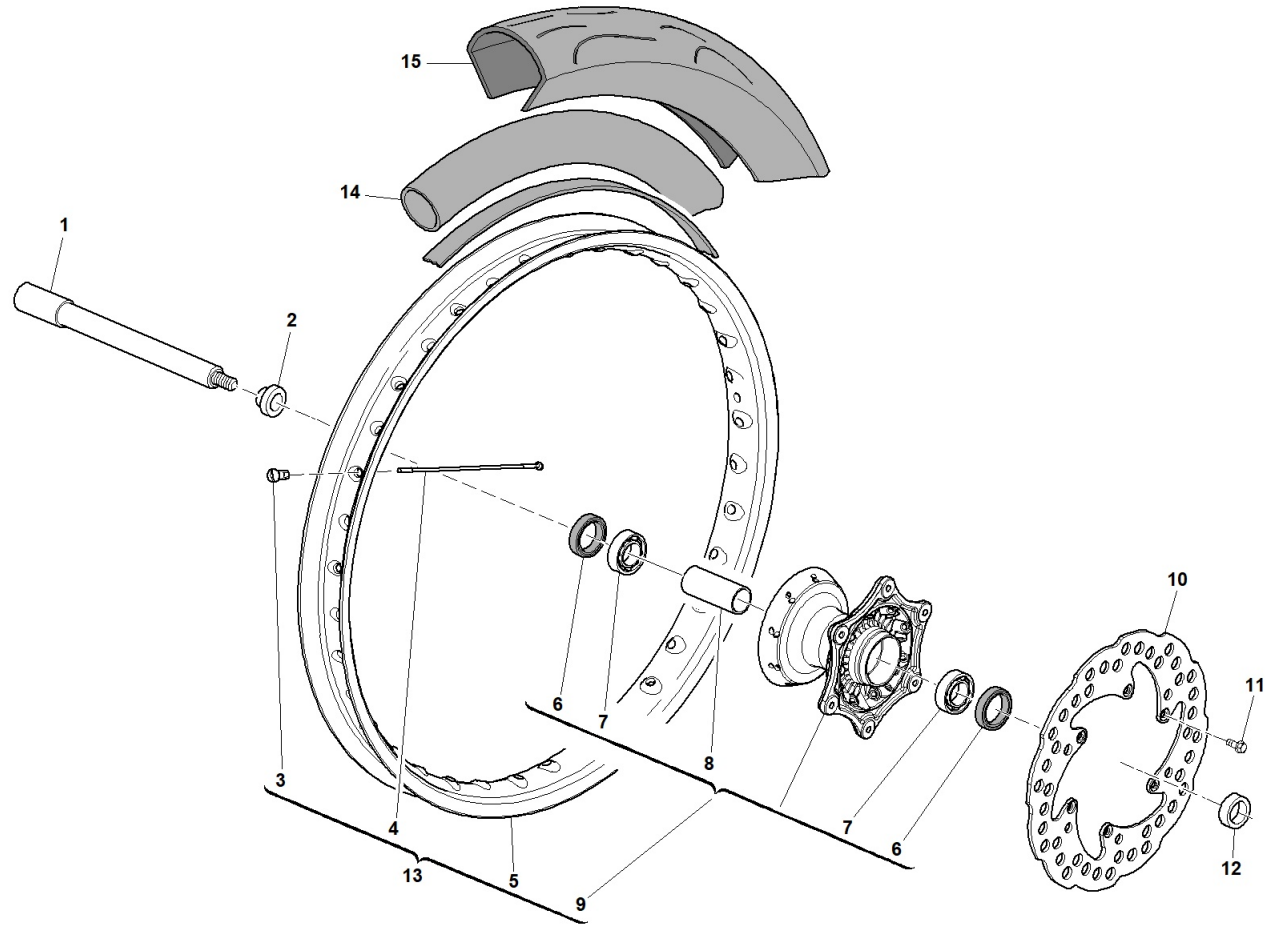





HANDLEBARS

N.		Part n°	Description	Notes	Notes	Taxable price (€)
23		KW2008502	LEVA FRIZIONE F125 NUDA			15,28
24		K01311005	COLLARE P/SPECCHIO M10 SINISTR			6,25
25		K02094100	MANOPOLA SX NERA			5,68
26		K01094937	GOMMINO SILENTBLOCK SERBATOIO			0,69
27		W24448	RONDELLA 4X16			1,39
28		K02094885	SUPPORTO PORTALEVA			9,03

FRONT WHEEL









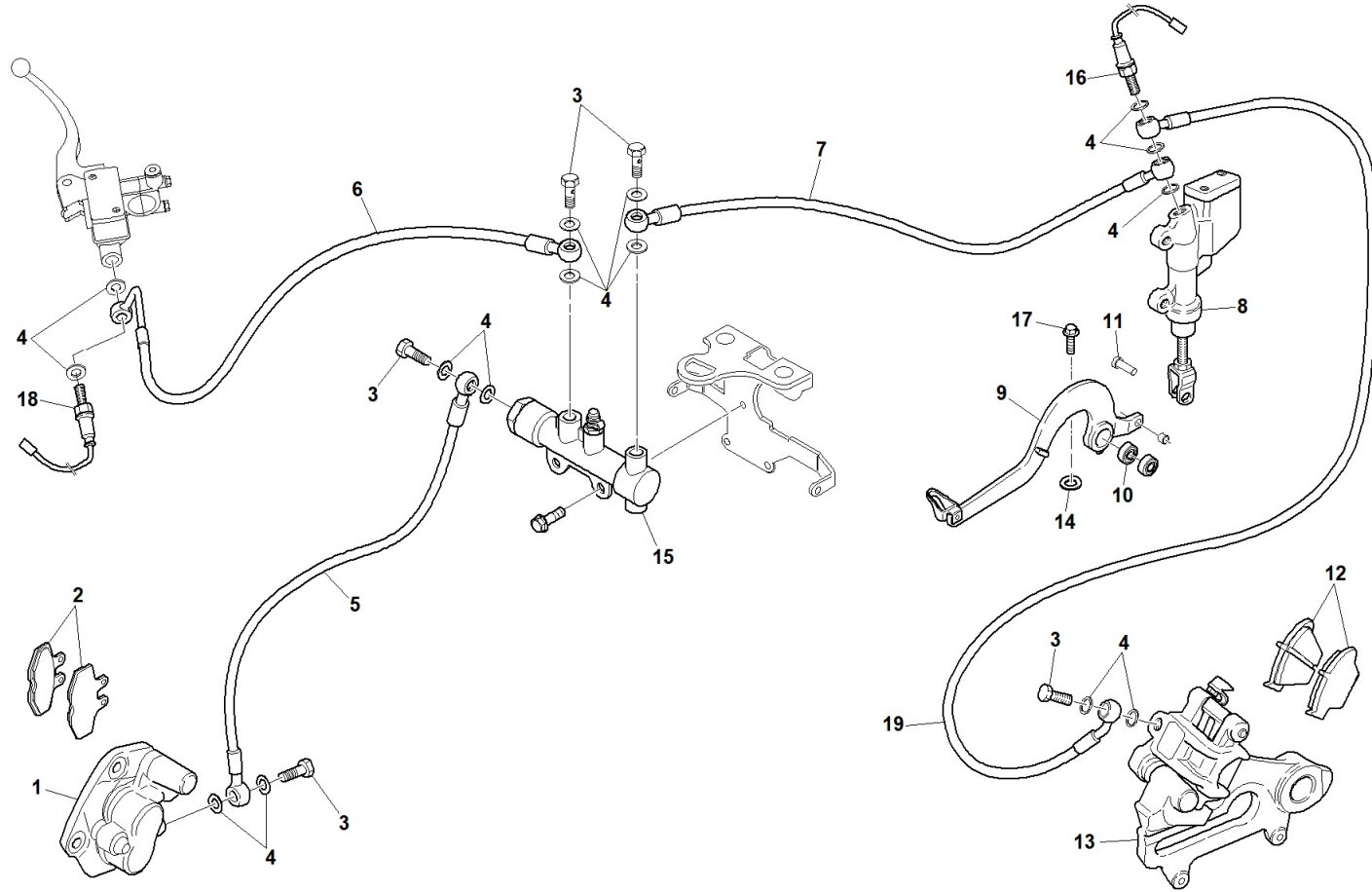













FRONT WHEEL

N.		Part n°	Description	Notes	Notes	Taxable price (€)
1		K01110110	PERNO RUOTA ANTERIORE MY20			14,58
2		K01122195	DISTANZ ANT DX 50RR RUOTE JH			4,75
5		KW1118MF7	CERCHIO 2.5X17	MOTARD - 17"		140,07
7		KW1122011	CUSCINETTO ANTERIORE SX-DX JH			8,40
8		KW1122015	DISTANZIALE MOZZO ANT JH			9,45
9		KW1122010	MOZZO ANTERIORE JH			69,30
10		K01318290	DISCO FRENO ANT. D.290 WAVE	D.290		109,88
11		W00464	VITE TBEI 6X14 7380 10.9 ZNB			2,78
12		K01122169	DISTANZ ANT SX 50RR RUOTE JH			4,38
14		K0112117A	CAMERA 100/80-17 TR6			20,21
15		11070X17	PNEUMATICO ANT. 110/70 X 17"			59,85

BRAKE SYSTEM



BRAKE SYSTEM

N.		Part n°	Description	Notes	Notes	Taxable price (€)
1		K01318152	PINZA FRENO ANTERIORE			93,24
2		K01319159	COPPIA PASTIGLIE FRENO ANT.			38,33
3		TA4300002	DADO RACCORDO TUBO FD			1,39
4		W24340	RONDELLA AL 10X14X1,5			1,39
5		KW1318187	TUBO PINZA ANT-RIPARTIT MY19			30,48
6		KW1318186	TUBO ANT-RIPARTIT MY19-20			19,17
7		KW1318188	TUBO POMPA POST-RIPART MY19-20			28,04
8		K01318161	POMPA POSTERIORE			98,11
9		KW3410195A	PEDALE FRENO POSTERIORE FE VER			52,82
10		K03410380	CUSCINETTO 608 2RS PED.FRENO			1,39
11		K03908100	SPINA FORCELLINO PEDALE FRENO			2,08
12		K01318169	COPPIA PASTIGLIE FRENO POST.			37,28
13		K01318162	PINZA FRENO POSTERIORE			113,02
14		W20341	RONDELLA 8X14X1,6 6592 ZNB			1,39
15		KW1318183	RIPARTITORE			97,71
16		K01318167	IDROSTOP POMPA FRENO POST.			15,28
17		W02013625	VITE TCE 8X25 5931 8.8 ZNB			1,39
18		K01318157	IDROSTOP POMPA FRENO ANT.			13,74
19		K01318166	TUBO PINZA-POMPA POST MY19			23,34

FRAME

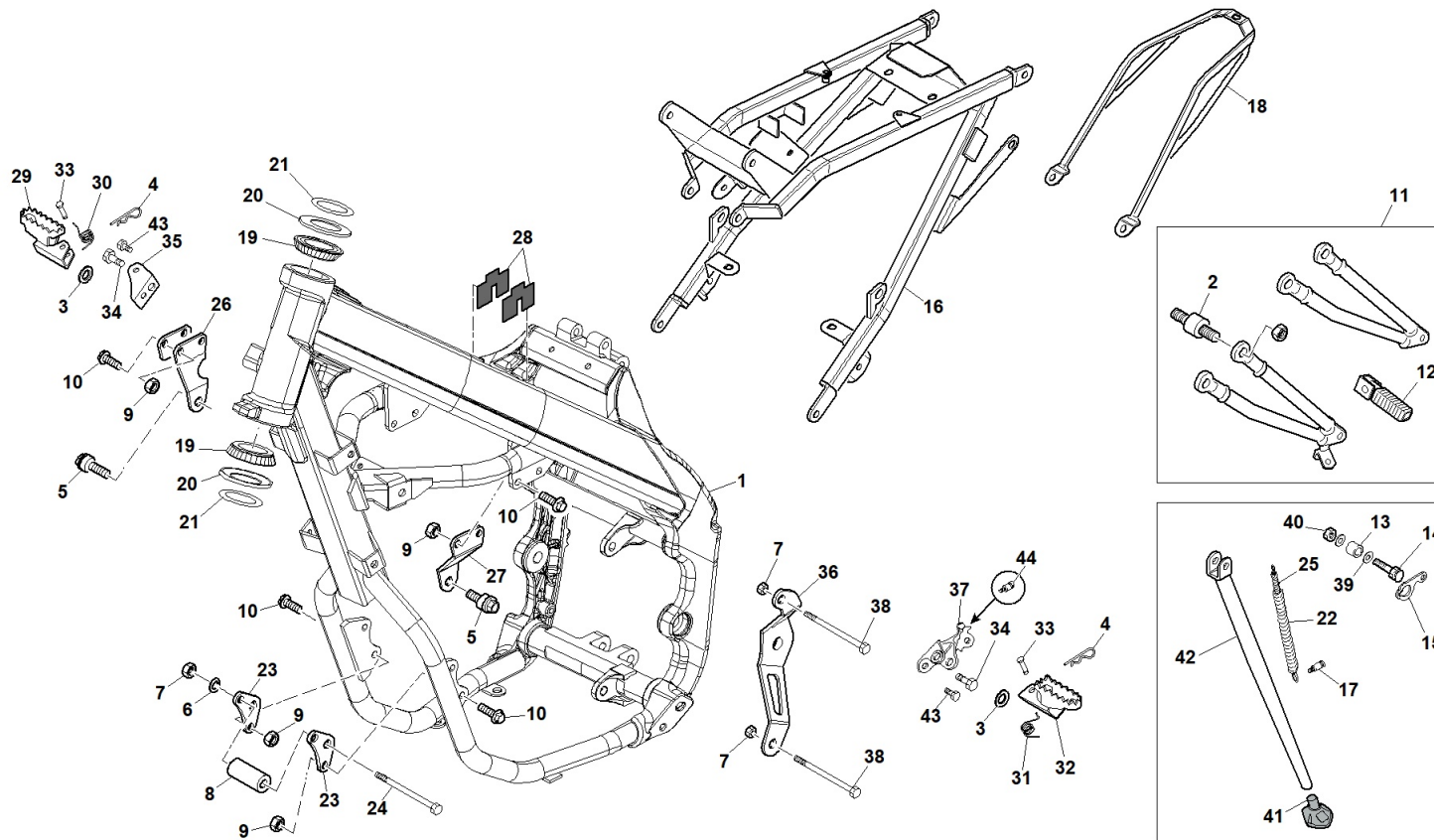

FRAME

N.		Part n°	Description	Notes	Notes	Taxable price (€)
2		K01009667	SILENTBLOCK M6X13 H7 MM			2,43
3		W00347	RONDELLA 8,4X17X1,6 UNI 6592			1,39
4		K01007940	COPIGLIA 2X20 PED.FRENO/PEDANE			1,11
5		W23461	VITE TCE 10X31 TORNITA			2,78
6		W00340	RONDELLA 10,5X21X2 UNI 6592			1,39
7		KW3708716	DADO AUTOBL.M10X1,25 7473 ZNB			4,32
9		W00945	DADO M8 ALTO FLANG AUTOBL.ZNB			2,78
10		TEF08X025	VITE TEF 8X25 FLANGIATA			1,39
11		K03410109	KIT PEDANE PASSEGGERO TEL.ALU			78,49
12		KW3408400	COPPIA PEDANE PASSEGGERO			28,00
13		K03707355	BUSSOLA CAVALLETTO ZNB			4,86
14		K03706315	VITE FISSAGGIO CAVALLETTO			6,95
15		KA3406120	PIASTRINA AGGANCIO MOLLA CAVAL			4,17
17		K03706335	PIOLO FISS.MOLLA CAV. M5 LUNGO			2,94
19		K03700200	CUSCINETTO STERZO 32005			11,81
20		KA1243700	RONDELLA PARAPOLVERE FORCELLA			4,17
21		KW1008280	OR PARAPOLVERE 42X2,6 VITON 70			2,84
22		K03806851	MOLLA ESTERNA CAVALLETTO			4,44
24		KW3721735	VITE POST SUP FISS MOTORE L151			10,40
25		K03806850	MOLLA INTERNA CAVALLETTO			4,17

FRAME

N.		Part n°	Description	Notes	Notes	Taxable price (€)
26		KW3421020	SUPPOR DX TESTA TELAIO 125 EU5			5,33
27		KW3421025	SUPPOR SX TESTA TELAIO 125 EU5			5,11
29		KA3406501	PEDANA POGGIPIEDI DX.			19,85
32		KA3406500	PEDANA POGGIPIEDI SX			19,85
33		KA3406505	PIOLO SUPPORTO PEDANA P/PIEDI			4,17
34		KA3406516	VITE M12 SUPPORTO PEDANA			4,17
35		KA3406515	SUPPORTO PEDANA DX			20,84
36		KW3421040	ATTACCO POST MOTORE 125 EU5			17,76
37		KA3406510	SUPPORTO CAVAL/PEDANA SX ALU			25,00
38		KW3708715	VITE POST.SUP.FISS.MOTORE (FE)			8,61
39		W00347	RONDELLA 8,4X17X1,6 UNI 6592			1,39
40		W00330	DADO M8 AUTOBL. BASSO UNI 7474			2,78
41		KW3421360	TAMPONE CAVALLETTO MY21			4,73
42		KW3421320	CAVALLETTO AL L305 C/TAMPONE			40,95
42		KW3421380	CAVALLETTO AL L260 C/TAMPONE			36,75
43		TEF08X016	VITE TEF 8X16 FLANGIATA			1,39
44		K03706345	PIOLO FISS.MOLLA CAV. M6 CORTO			2,94

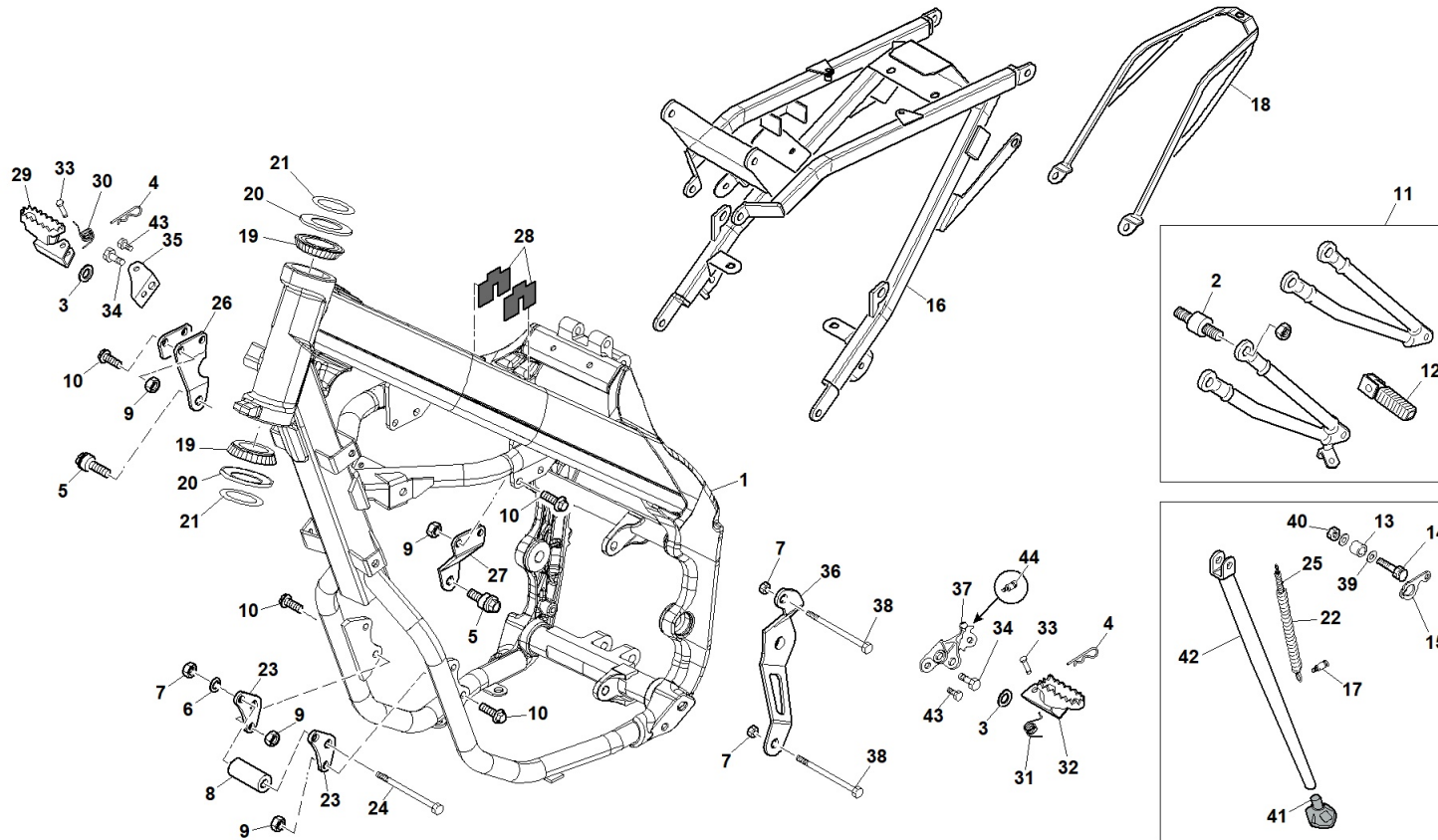

FRAME



FRAME

N.		Part n°	Description	Notes	Notes	Taxable price (€)
2		K01009667	SILENTBLOCK M6X13 H7 MM			2,43
3		W00347	RONDELLA 8,4X17X1,6 UNI 6592			1,39
4		K01007940	COPIGLIA 2X20 PED.FRENO/PEDANE			1,11
5		W23461	VITE TCE 10X31 TORNITA			2,78
6		W00340	RONDELLA 10,5X21X2 UNI 6592			1,39
7		KW3708716	DADO AUTOBL.M10X1,25 7473 ZNB			4,32
9		W00945	DADO M8 ALTO FLANG AUTOBL.ZNB			2,78
10		TEF08X025	VITE TEF 8X25 FLANGIATA			1,39
11		K03410109	KIT PEDANE PASSEGGERO TEL.ALU			78,49
12		KW3408400	COPPIA PEDANE PASSEGGERO			28,00
13		K03707355	BUSSOLA CAVALLETTO ZNB			4,86
14		K03706315	VITE FISSAGGIO CAVALLETTO			6,95
15		KA3406120	PIASTRINA AGGANCIOLLO Molla CAVAL			4,17
17		K03706335	PIOLO FISS.MOLLA CAV. M5 LUNGO			2,94
19		K03700200	CUSCINETTO STERZO 32005			11,81
20		KA1243700	RONDELLA PARAPOLVERE FORCELLA			4,17
21		KW1008280	OR PARAPOLVERE 42X2,6 VITON 70			2,84
22		K03806851	MOLLA ESTERNA CAVALLETTO			4,44
24		KW3721735	VITE POST SUP FISS MOTORE L151			10,40
25		K03806850	MOLLA INTERNA CAVALLETTO			4,17



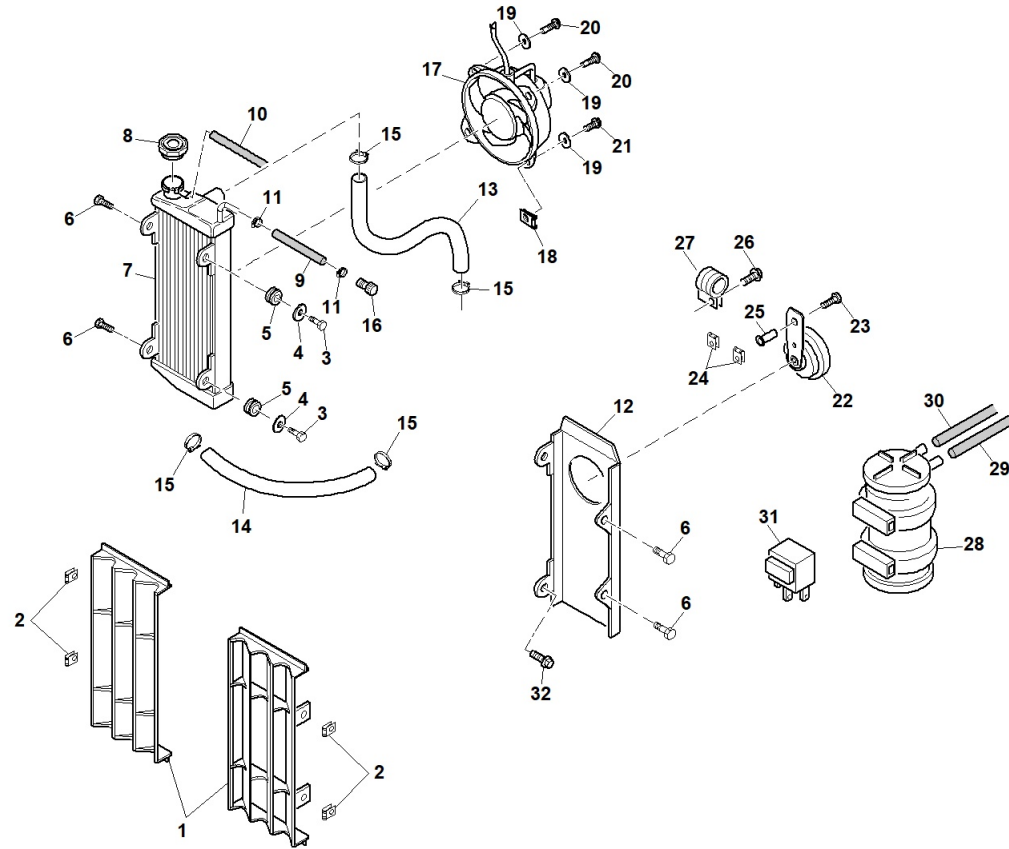

FRAME

N.		Part n°	Description	Notes	Notes	Taxable price (€)
26		KW3421020	SUPPOR DX TESTA TELAIO 125 EU5			5,33
27		KW3421025	SUPPOR SX TESTA TELAIO 125 EU5			5,11
29		KA3406501	PEDANA POGGIPIEDI DX.			19,85
32		KA3406500	PEDANA POGGIPIEDI SX			19,85
33		KA3406505	PIOLO SUPPORTO PEDANA P/PIEDI			4,17
34		KA3406516	VITE M12 SUPPORTO PEDANA			4,17
35		KA3406515	SUPPORTO PEDANA DX			20,84
36		KW3421040	ATTACCO POST MOTORE 125 EU5			17,76
37		KA3406510	SUPPORTO CAVAL/PEDANA SX ALU			25,00
38		KW3708715	VITE POST.SUP.FISS.MOTORE (FE)			8,61
39		W00347	RONDELLA 8,4X17X1,6 UNI 6592			1,39
40		W00330	DADO M8 AUTOBL. BASSO UNI 7474			2,78
41		KW3421360	TAMPONE CAVALLETTO MY21			4,73
42		KW3421320	CAVALLETTO AL L305 C/TAMPONE			40,95
42		KW3421380	CAVALLETTO AL L260 C/TAMPONE			36,75
43		TEF08X016	VITE TEF 8X16 FLANGIATA			1,39
44		K03706345	PIOLO FISS.MOLLA CAV. M6 CORTO			2,94











RADIATOR



RADIATOR

N.		Part n°	Description	Notes	Notes	Taxable price (€)
1		K07094250	GRIGLIA RADIATORE			8,34
2		K03612131	CLIPS M5 CORTA ZNB(CR3)			1,39
3		TEF06X020	VITE TEF 6X20 FLANGIATA			1,39
5		K01094505	GOMMINO RADIATORE			0,83
6		TEF06X016	VITE TEF 6X16 FLANGIATA ZNB			1,39
7		KW7021400	RADIATORE 125-4T EU5			89,52
8		K07018150	TAPPO RADIATORE TONDO 1.4			12,79
9		KW1008550	TUBO GIUNZ.SFIATI RAD.HM125 4T			5,68
10		K01612950	TUBO COPOLAN UML MM 5X9 ROTOLO			4,59
11		K03412704	FASCETTA BANDA FORATA W2 D 16			2,87
13		KW1021630	TUBO RITORNO RAD/TESTA 125- EU5			11,29
14		KW1021620	TUBO MANDATA RAD/TESTA 125-EU5			6,30
15		TA3492115	FASCETTA TUBO RAD. 16X27 W2			1,49
16		K03912100	TAPPINO PER RADIATORE			2,78
17		KW7018400	VENTOLA 12V RAD.125 4T			70,56
18		K03612131	CLIPS M5 CORTA ZNB(CR3)			1,39
19		W00378	RONDELLA 5X15X1,5 ZNB DIN 9021			1,39
20		W00432	VITE TBEI 5X14 7380 10.9 ZNB			0,26
21		W21335	VITE TBEI 5X40			2,78
23		TEF06X035	VITE TEF 6X35 FLANGIATA			1,39

RADIATOR

N.		Part n°	Description	Notes	Notes	Taxable price (€)
24		W00441	CLIPS M6			1,39
25		KW2821451	BUSSOL DIST CLACSON 125-4T EU5			0,66
26		TEF06X010	VITE TEF 6X10 FLANGIATA ZNB			1,39
27		KW1008006	PASSACAVO GOMM. D.6 FORO 6,5			8,51
28		K03621650	GRUPPO CANISTER MY21 50CC			18,30
29		K01612950	TUBO COPOLAN UML MM 5X9 ROTOLO			4,59
30		K03621660	TUBO CANISTER 4,5X8,5 COPOLAN			4,63
31		KW2808085	INTERMITTENZA PER FRECCHE A LED			12,93
32		W20335	VITE TBEI 5X16 ISO 7380 C.10.9			2,87